

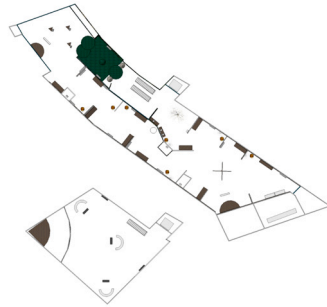



Heal Harm Protect

Table of Contents

Executive Summary	3	Graphic System	43
Conceptual Approach Statement	4	Color Palette & Typography	44
Concept Diagram	5	Graphic Look and Feel	45
Audience and Goals	6	Logo	46
Client	7	Poster & Marketing Collateral	47
Venue	8	Post Engagement Collateral	48-50
Thesis Statement	9	Graphic Family	51
Simplified Plan	10	Exhibit Intro Image	52
Exterior Wayfinding	11-12	Exhibit Intro Elevation	53
Exterior Wayfinding Location Plan	13	Exhibit Intro Side Elevation & Plan	54
Introduction	14	Area Intro Sign Image	55
The Village	15-16	Area Intro Sign Elevations	56
Storytelling	17	Content Graphics Image	57
Marriage	18	Content Graphics Elevations	58
Display Case Ghost Silhouettes	19	Label Rail Image	59
Local Community Objects	20	Label Rail Elevations	60
Fireside Seanchai	21-22	Directive Image & Elevation	61
Birth	23	Exterior Wayfinding Image	62
Festival	24	Exterior Wayfinding Elevation	63
Death	25	Interior Wayfinding Image	64
The Otherworld	26	Interior Wayfinding Elevation	65
Schedules and Lists	27	Exhibition Detailing	66
Graphic Schedule	28-30	Area 1 Image	67
Graphic Specs	31	Area Detail Plan	68
AV Schedule	32	Elevations and Details	69-70
Material Schedule	33	Content Graphic Detailing	71
Material Plan	34	Community Object Case Detailing	72
Lighting Schedule	35	Area 2 Image	73
Artifact List	36	Area Detail Plan	74
General Plan	37	Elevations and Details	75
Dimension Plan	38	Technifex Fire Detailing	76
Graphic Location Plan	39	Storytelling Performance Detailing	77
Power and Data Plan	40		
Gallery Sections	41-42		



 Heal Harm Protect	
Caroline Siavichay	
PROJECT	Heal Harm Protect
CLIENT	National Museum of Ireland
DATE	12.06.23
GRAPHIC TYPE	
GRAPHIC NO.	
SCALE	
NOTES	
KEY PLAN	
PAGE NO.	 School of Graduate Studies
2	



Executive Summary

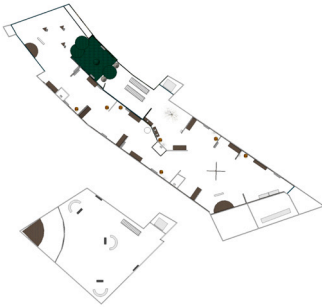

Conceptual Approach Statement

To foster community connection by creating a space that gives a sense of ownership and accessibility to local community members while engaging all visitors in an immersive cultural experience that brings the magic of Irish folk customs to life in an unforgettable way.

 Heal Harm Protect	
Caroline Siavichay	
PROJECT	Heal Harm Protect
CLIENT	National Museum of Ireland
DATE	12.06.23
GRAPHIC TYPE	
GRAPHIC NO.	
SCALE	
NOTES	
KEY PLAN	
	
PAGE NO.	 School of Graduate Studies
4	

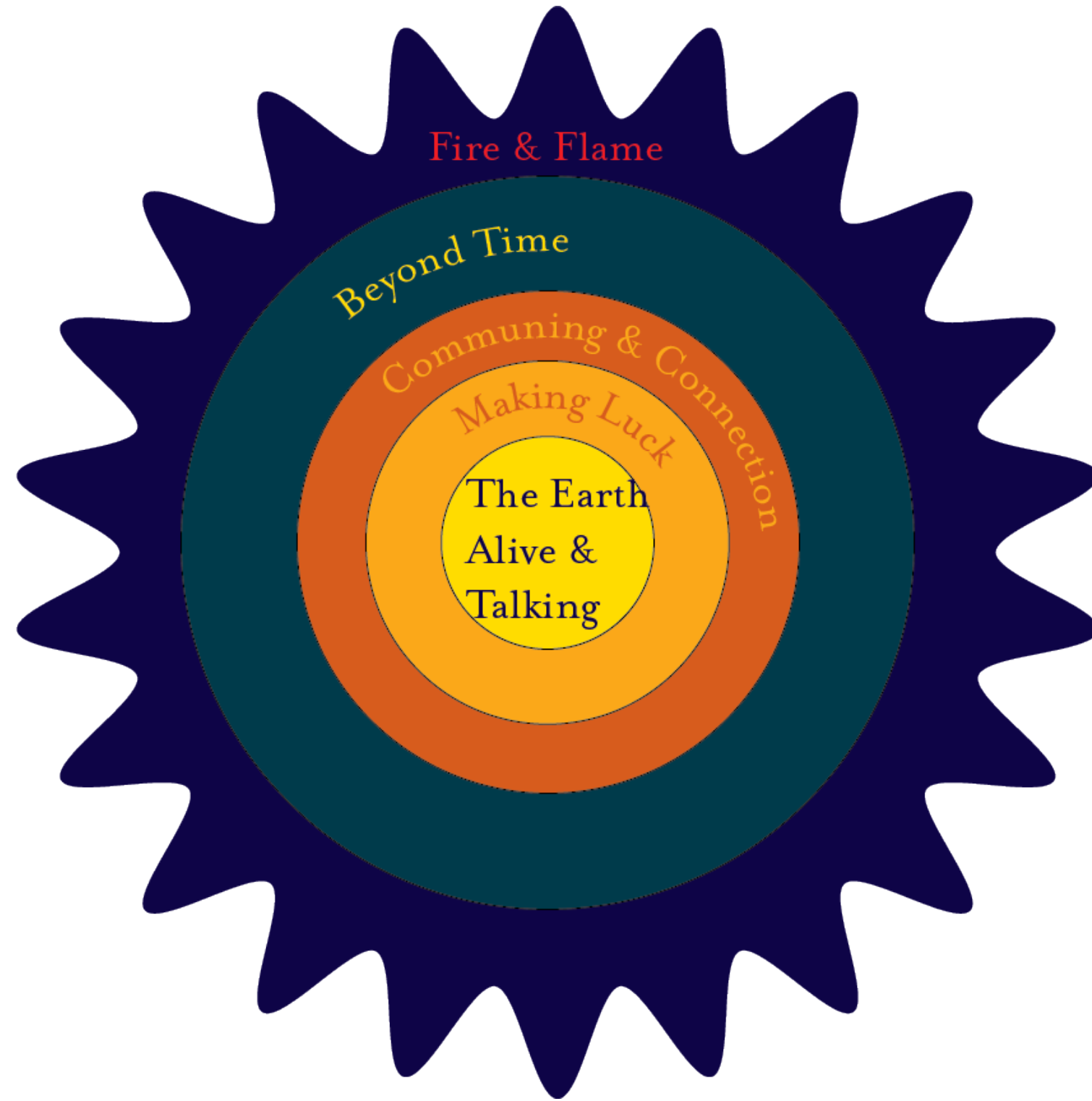
Concept Diagram

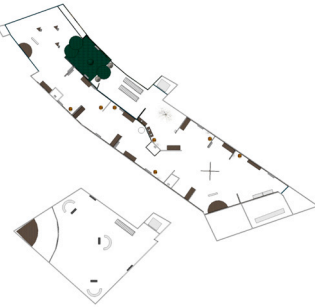

	Heal Harm Protect
Caroline Siavichay	
PROJECT	Heal Harm Protect
CLIENT	National Museum of Ireland
DATE	12.06.23
GRAPHIC TYPE	
GRAPHIC NO.	
SCALE	
NOTES	
KEY PLAN	
PAGE NO.	 School of Graduate Studies
5	

Audience & Goals

AUDIENCE

Families + School Groups, Professional/Hobbyists, Explorers

Tourists (May - September)

Locals (October - April)

GOALS

PROJECT:

- Expand audience
- Increase attendance
- Modernize design approach
- Serve the stories of objects in the National Folklife Collection

EDUCATIONAL:



- Understand significance of nature and elements in Irish folklore and culture
- Learn new stories
- Understand how folklore has impacted life, community and culture in the past and today

EXPERIENCE:

- Feel transported by atmospheric design and engaged by content
- Shock & awe
- See familiar content in new way
- Multi-sensory

SOCIAL:

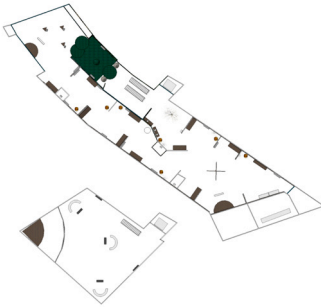
- Create connection between community/fellow viewers
- Encourage prosocial behavior
- Use design techniques to foster communal atmosphere and activities

 Heal Harm Protect	
Caroline Siavichay	
PROJECT	Heal Harm Protect
CLIENT	National Museum of Ireland
DATE	12.06.23
GRAPHIC TYPE	
GRAPHIC NO.	
SCALE	
NOTES	
KEY PLAN	
	
PAGE NO.	 School of Graduate Studies
6	

NATIONAL MUSEUM OF IRELAND – COUNTRY LIFE

MISSION:

“TO COLLECT, CARE FOR,
MANAGE & INTERPRET
THE COLLECTIONS
WHILE MAKING THEM
ACCESSIBLE AS A
SOURCE OF LEARNING
AND ENJOYMENT FOR A
WIDE RANGE OF DIVERSE
AUDIENCES.”

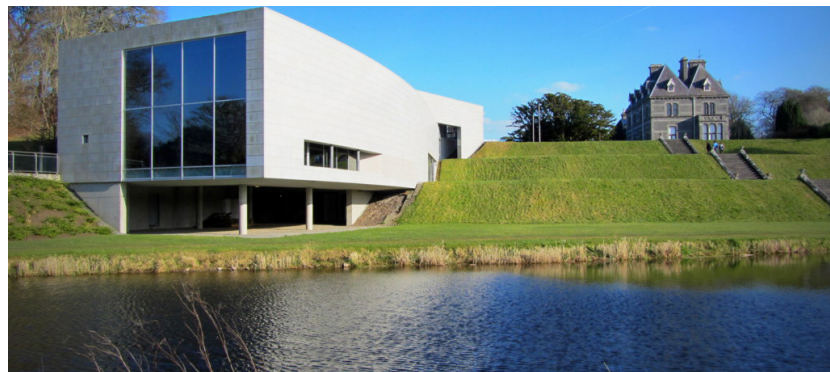



LOCATION & INFO

- Turlough Park, Castlebar, Co. Mayo
- Free Admisson
- Tuesday to Saturday, 10am to 5pm
- Sunday and Monday, 1pm to 5pm
- Closed Christmas Day, St. Stephen’s Day and Good Friday
- Wheelchair Accessible

HISTORY

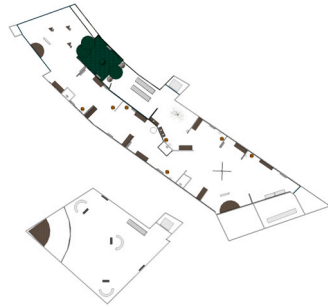
Turlough Park House was owned by the Fitzgerald family until 1991 when it was purchased by Mayo County Council. In 1995, the council made the decision to locate part of the National Museum of Ireland here. The Museum’s Folklife collections had been stored for a long time in Daingean, Co. Offaly, awaiting a suitable venue. As the house was not suitable as a major exhibition space, a new building housing the museum galleries was purpose-built alongside it.

 Heal Harm Protect	
Caroline Siavichay	
PROJECT	Heal Harm Protect
CLIENT	National Museum of Ireland
DATE	12.06.23
GRAPHIC TYPE	
GRAPHIC NO.	
SCALE	
NOTES	
KEY PLAN 	
PAGE NO.	 School of Graduate Studies
7	

Venue

NATIONAL MUSEUM OF IRELAND – COUNTRY LIFE

01.FEB.2024 – 31.JAN.2025



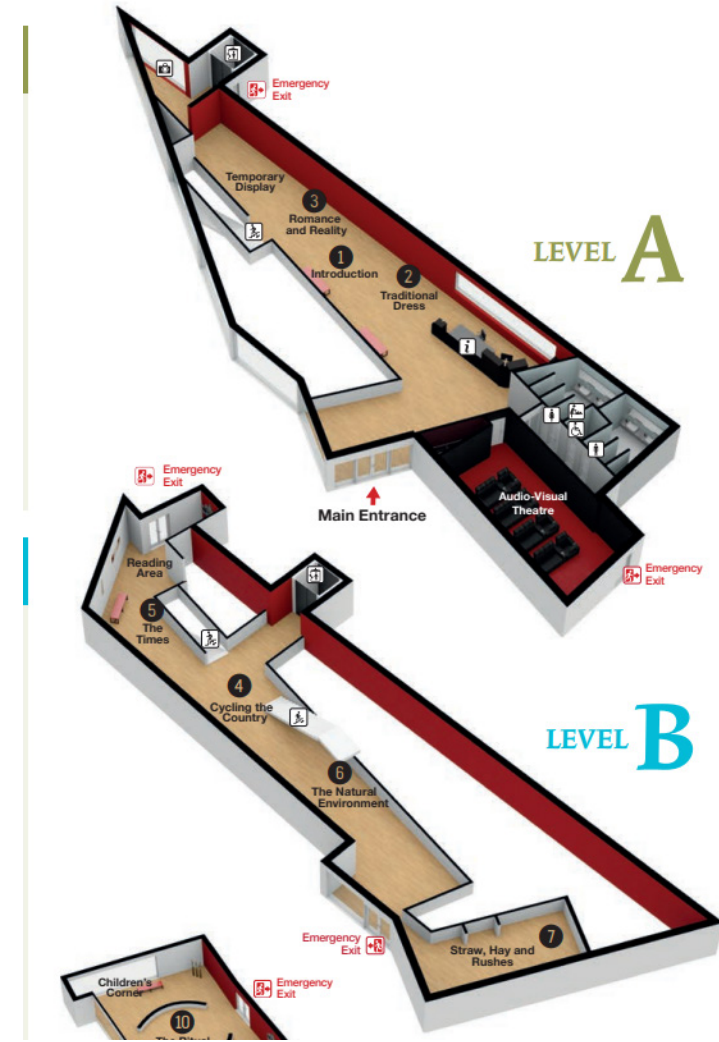

- 1. Glasshouse
- 2. Model Thatch Cottage
- 3. Oldest Tree
- 4. Greenway
- 5. 18th Century Ruin
- 6. Round Tower

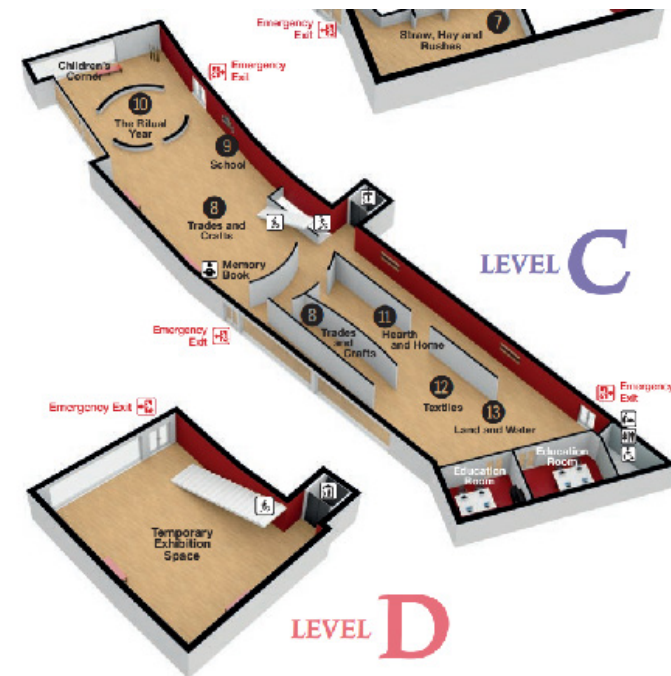

Gallery Floor Plans

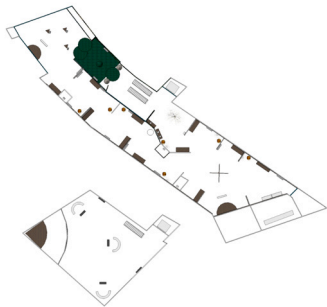

Gallery Floor Plans

 Heal Harm Protect	
Caroline Siavichay	
PROJECT	Heal Harm Protect
CLIENT	National Museum of Ireland
DATE	12.06.23
GRAPHIC TYPE	
GRAPHIC NO.	
SCALE	
NOTES	
<p>KEY PLAN</p> 	
PAGE NO.	
8	 School of Graduate Studies



Thesis Statement

Modern museums have become more than spaces for academic exploration that solely foster intellectual well-being. These modern institutions have evolved into sacred spaces of community ritual and synergy that are fostering social well-being in an unprecedented way.

However, this phenomenon of societal cohesion and well-being is going largely underutilized, as many exhibitions are still designed with primarily intellectual learning outcomes in mind.

Understanding why and just how deeply the use of museums as ritual spaces can positively impact the social well-being of a surrounding community gives designers the opportunity to expand the scope of their intended project outcomes to include goals of fostering prosocial behavior and improving societal well-being.

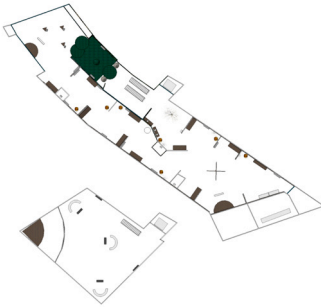
Through the sequencing of design elements to strategically include moments of shared group experiences, both synchronous and complementary, interspersed with opportunities for individual rest and reflection, museums can accomplish these goals in order to better contribute to the overall well-being of communities.

 Heal Harm Protect	
Caroline Siavichay	
PROJECT	Heal Harm Protect
CLIENT	National Museum of Ireland
DATE	12.06.23
GRAPHIC TYPE	
GRAPHIC NO.	
SCALE	
NOTES	
KEY PLAN	
PAGE NO.	 School of Graduate Studies
9	

Simplified Plan

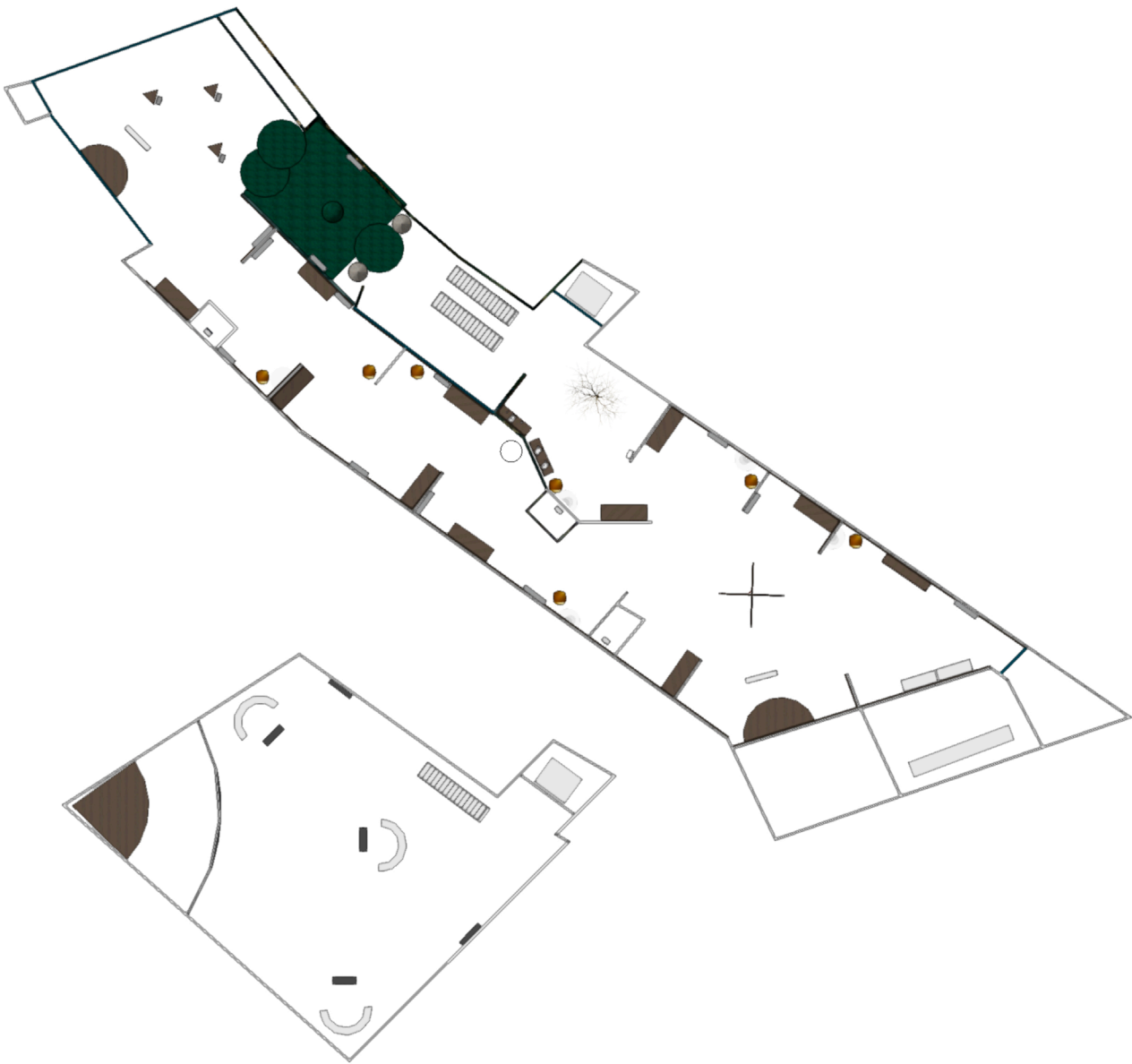

1 Level C & D Plan
Scale: 1/32" = 1'-0"



Caroline Siavichay

PROJECT Heal Harm Protect

CLIENT National Museum of Ireland

DATE 12.06.23

GRAPHIC TYPE

GRAPHIC NO.

SCALE

NOTES

KEY PLAN

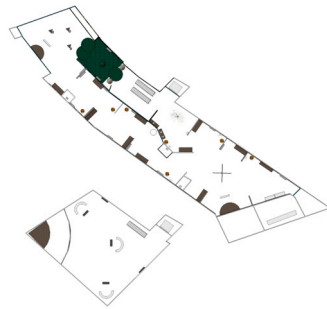

PAGE NO.

10





Exterior Wayfinding

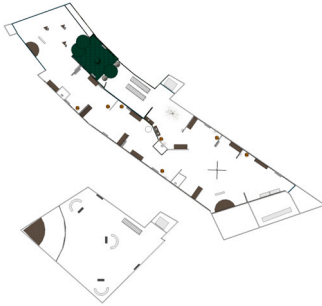

Entrance Banners

Upon entering the museum grounds from the highway, visitors will see a banner advertising the exhibition and providing information about when and where it can be found in the museum.



 Heal Harm Protect	
Caroline Siavichay	
PROJECT	Heal Harm Protect
CLIENT	National Museum of Ireland
DATE	12.06.23
GRAPHIC TYPE	
GRAPHIC NO.	
SCALE	
NOTES	
<p>KEY PLAN</p> 	
PAGE NO.	 School of Graduate Studies
11	

Exterior Wayfinding

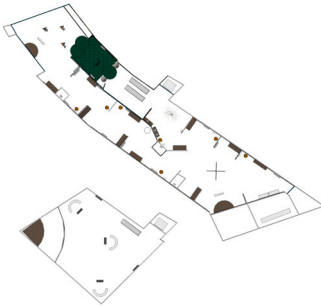

Will-o-the-Wisp Guides

In their inactive state, the wayfinding structures will appear to be semi-transparent blue glass orbs. As visitors approach, the orbs will be activated by motion sensors that turn on the internal illumination and reveal the gold writing that provides information about the location and dates of the exhibit. This will not only inform and intrigue visitors about the exhibit by creating an atmosphere of magic and mystery, it will also aid in orienting visitors toward the museum while traversing the extensive grounds.

 Heal Harm Protect	
Caroline Siavichay	
PROJECT	Heal Harm Protect
CLIENT	National Museum of Ireland
DATE	12.06.23
GRAPHIC TYPE	G
GRAPHIC NO.	08A.01.GR01
SCALE	
NOTES	
<p>KEY PLAN</p> 	
PAGE NO.	
12	 School of Graduate Studies

Exterior Wayfinding Location Plan



Caroline Siavichay

PROJECT Heal Harm Protect

CLIENT National Museum of Ireland

DATE 12.06.23

GRAPHIC TYPE

GRAPHIC NO.

SCALE

NOTES

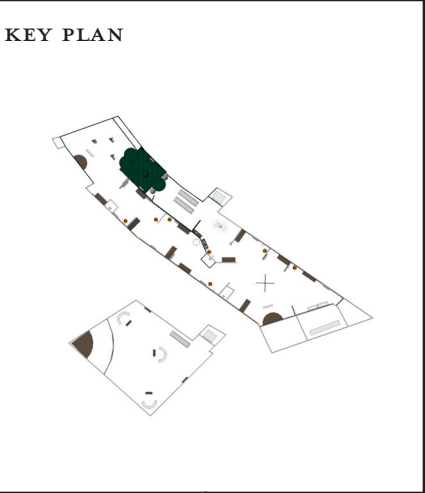

PAGE NO.
13





Introduction

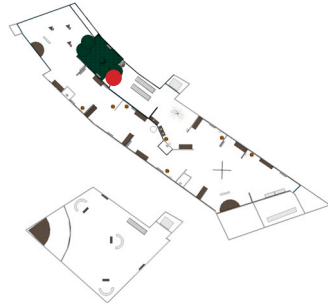

A Million Welcomes

Upon entry, visitors will see the introductory panel to the left, which will give them a basic overview of the exhibit and help them to easily identify the entry. They will also see a large iron welcome sign over the entry supported by two stone pillars, which makes reference to the stone and iron gates of the rural Irish fields. Beyond the gates, they will see the "field area" marked by interactive LED flooring and a small "fairy hill". On the mural covered walls of this area there will be signage that teaches visitors about the folk custom of avoiding building homes wherever there is a "fairy path", where it is said the fairies cross during the night. These fairy paths are made visible by gold illuminated footprints left by visitors on the interactive flooring, which places visitors into the narrative of the exhibit by informing them that no village can be built in this area and we must search for land with no fairy paths. This will set the precedence of the narrative and contribute to an immersive, moody atmosphere of magic.



 Heal Harm Protect	
Caroline Siavichay	
PROJECT	Heal Harm Protect
CLIENT	National Museum of Ireland
DATE	12.06.23
GRAPHIC TYPE	A & B
GRAPHIC NO.	01.A01.GR03-04
SCALE	
NOTES	
<p>KEY PLAN</p> 	
PAGE NO.	 School of Graduate Studies
14	

The Village

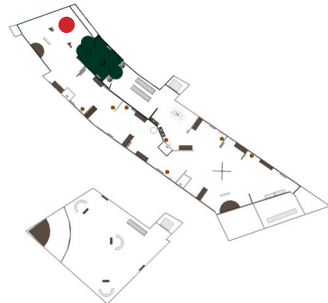

Building a Community

In this area, visitors will learn about the protective folk custom of burying significant objects under the foundation once an appropriate place to build a home has been found. Visitors will first see a wall that shows a wall mural of a cottage built on a hill. There will be hidden panels of smart glass within the mural. These panels will be initially undetectable to observers, as in their inactive state they display a smart film that blends with the mural. There will be directive graphics on the floor which direct visitors to stand close to the wall. Upon standing on the floor graphics, the nearby panels of motion sensor smart glass will be activated and the film that matches the mural will disappear, turning them to clear glass and exposing small display cases within the wall that showcase artifacts that were found buried under foundations for protective purposes. There will be label copy in the display cases providing more information about the objects.



 Heal Harm Protect	
Caroline Siavichay	
PROJECT	Heal Harm Protect
CLIENT	National Museum of Ireland
DATE	12.06.23
GRAPHIC TYPE	F
GRAPHIC NO.	02A.02.GR01
SCALE	
NOTES	
KEY PLAN	
PAGE NO.	
15	 School of Graduate Studies

The Village

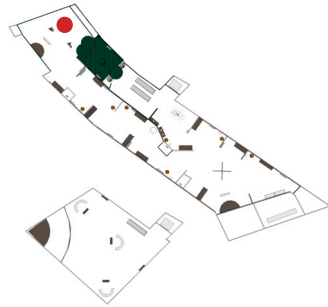

Protecting Your Home

Next in this area, there will be several triangular display cases showing more protective artifacts. Near these cases, there will be interactive screens that give more information about the protective qualities that these once-buried objects possess. The screens then allow visitors to draw an item that they feel is protective in nature and that they would bury under their own home for that purpose. These drawings are then projected on the back wall mural that depicts rolling gold and green hills. This allows for a moment of introspection while also contributing to a larger whole. Seeing the drawings of other visitors projected on the wall will also aid in building feelings of community and connection, as well as empathy for others.



 Heal Harm Protect	
Caroline Siavichay	
PROJECT	Heal Harm Protect
CLIENT	National Museum of Ireland
DATE	12.06.23
GRAPHIC TYPE	AV4
GRAPHIC NO.	02A.02.GR08
SCALE	
NOTES	
KEY PLAN	
	
PAGE NO.	 School of Graduate Studies
16	

Storytelling

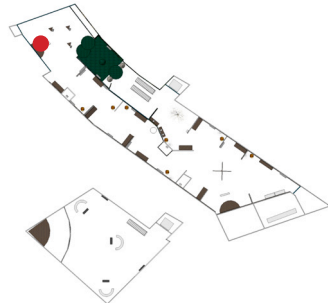

Gather 'round

Storytelling areas feature a small stage for the performer, a bench for visitors to sit and listen, and a large dark green wall. Here, visitors will learn traditional tales from Irish folklore told in a traditionally Irish dramatic fashion, which allows visitors to experience an authentic piece of local culture rather than just reading about it. As each storytelling session proceeds, the dark green wall will feature projection mapped images that enhance the storytelling by interacting with the performer and help to bring the tales to life. This will aid in creating a communal atmosphere by casting all visitors in the role of the audience and allowing them to share a common experience of witnessing an event in synchrony. The projection mapping will also aid in creating an atmosphere of magic and mystery.



 Heal Harm Protect	
Caroline Siavichay	
PROJECT	Heal Harm Protect
CLIENT	National Museum of Ireland
DATE	12.06.23
GRAPHIC TYPE	AV3
GRAPHIC NO.	02A.02.GR18
SCALE	
NOTES	
KEY PLAN	
	
PAGE NO.	 School of Graduate Studies
17	

Marriage

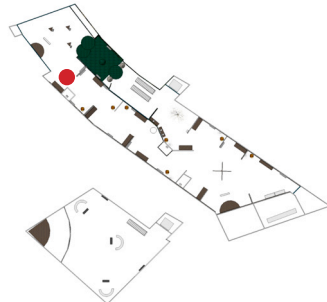

Something Old, Something New

Marriage is the first space that is meant to feel as though it is the interior of a home, as each home interior area is based around a special day in the home. After entering through a golden archway of trees, visitors will see limestone-washed walls. Hanging from the ceiling will be golden branch chandeliers, meant to symbolize the peat and rush torches traditionally used to light homes. They will also see large stone panels with main quotes/pull out facts cut into the stone. These quotes/facts will be backlit in a way that makes them seem to flicker like a fire in a stone hearth. There will also be content info graphic panels shaped like rounded windows on the walls. These give in depth information about the customs and beliefs related to the artifacts on display. There will also be display cases with artifacts related to weddings and marriage. On the back wall inside the display case, there will be projected silhouettes interacting with the artifacts. Visitors will also be able to view special related items collected from the local community and hear first hand accounts about them. They will also be able to record their own stories in the Fireside Seanchai booths. The overall atmosphere is cozy and communal with a vein of magical mystery running through it.

 Heal Harm Protect	
Caroline Siavichay	
PROJECT	Heal Harm Protect
CLIENT	National Museum of Ireland
DATE	12.06.23
GRAPHIC TYPE	C
GRAPHIC NO.	03A.01.GR01
SCALE	
NOTES	
KEY PLAN 	
PAGE NO.	
18	 School of Graduate Studies

Display Case Ghost Silhouettes



A Beautiful Haunting

Throughout the areas of the exhibit that are meant to feel like home interiors on important days, there will be large cases displaying relevant artifacts from the National Folklore Collection. On the back wall inside each display case, there will be projected silhouettes that are meant to represent the ghosts of the original owners of the artifacts. The silhouettes will interact with the artifacts as they would have on these special days (marriages, births, festivals and deaths). The silhouettes will glide in and out of view at regular intervals and are not activated by visitors, creating the sense that these ghosts are not aware of the visitors and are existing in their own realm where they replay these important, treasured moments from their old lives. When a ghost "picks up" an object, it will appear as a silhouette in their hand, creating the illusion that they are pulling the ghost of a former life out of the object.



Heal
Harm
Protect

Caroline Siavichay

PROJECT Heal Harm Protect

CLIENT National Museum of Ireland

DATE 12.06.23

GRAPHIC TYPE

GRAPHIC NO.

SCALE

NOTES

KEY PLAN

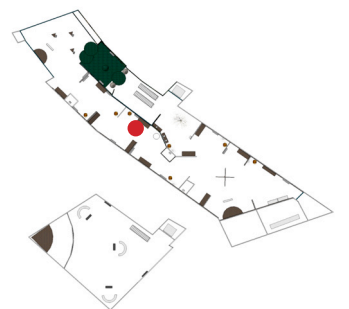

PAGE NO.

19





School of
Graduate Studies

Local Community Objects

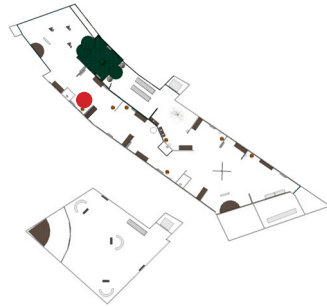

Local Legacies

Throughout the areas of the exhibit that are meant to feel like home interiors on important days, there will be rounded smart glass cases containing items collected from the local community. These items will be both important to their owners and relevant to the area that they are placed in (marriage, birth, festivals or death). In their inactive state, the glass will have an opaque frosted appearance. Next to the case on a golden branch table, there will be a recreation of an item related to the special object- for example, on the table next to the collected wedding dress there will be a small sewing kit. This related item on the table will have a directive graphic that instructs visitors to touch the object to activate the display. Once activated, a first person narrative recorded by the owner of the collected object will play through directional mics. As it plays, the smart glass on the object case will begin to become transparent, slowly revealing the object inside.



 Heal Harm Protect	
Caroline Siavichay	
PROJECT	Heal Harm Protect
CLIENT	National Museum of Ireland
DATE	12.06.23
GRAPHIC TYPE	
GRAPHIC NO.	E
SCALE	03A.01.GR15
NOTES	
KEY PLAN 	
PAGE NO.	
20	 School of Graduate Studies

Fíresíde Seanchaí

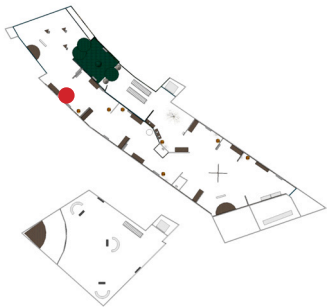

Tell Us a Tale

In the Marriage, Birth and Festival areas, there will be brick booths with an interactive screen inside. On the back wall, there will be a fire gobo projection giving the impression of a hearth fire. On the side wall, there will also be a content graphic giving information about the tradition of the seanchai, who are the fireside storytellers of Ireland. On the interactive touch screen, visitors will be encouraged to respond to one of the prompt questions on the screen by recording their own short story about a day in their own life related to the content area (marriage, birth or festival). This story will later be shared with another visitor. Once they finish recording, they will receive a small card with a QR code on it that will allow them to listen to a story that another visitor to the booth has recorded. This is also how their story will be shared with another visitor.

 Heal Harm Protect	
Caroline Siavichay	
PROJECT	Heal Harm Protect
CLIENT	National Museum of Ireland
DATE	12.06.23
GRAPHIC TYPE	AV4
GRAPHIC NO.	03A.01.GR06
SCALE	
NOTES	
<p>KEY PLAN</p> 	
PAGE NO.	 School of Graduate Studies
21	

Fireside Seanchaí Graphic Storyboard

**Fáilte a seanchaí!
Welcome storyteller!**

The Irish tradition of seanchaí meaning "storyteller" in Gaelic, is an important person who preserves and shares the rich oral history of the Emerald Isle. These storytellers are entrusted with the task of passing down tales of myth, legend, and everyday life from one generation to the next.

Tell us a tale!

Choose a story from your own life to record. This recording will be sent to another visitor who uses this booth at a later time, so please use appropriate language. You will have 20 seconds to tell your tale.

- What was the best wedding you've ever been to?
- What is a common wedding tradition in your culture/family?
- What was special about your wedding?

Recording...

20

Thank you for sharing!



Don't forget to take your ticket below to receive a story from another visitor in 24 hours.
Go raibh maith agat as cuairt a thabhairt ar Ard-Mhúsaem na hÉireann - Saol na Tuaithe.

**Fireside Seanchaí:
The Tale of a Friend**

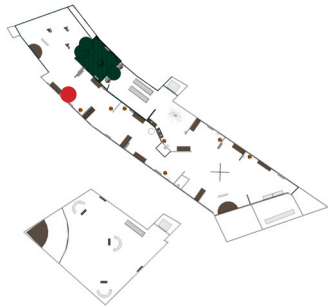

Scan this QR code after your visit to listen to another story recorded in this booth. Bain sult as!

Thank you for visiting
Heal Harm Protect
at the National Museum of Ireland - Country Life.
Slan, Agus Beannacht de leath.



 Heal Harm Protect	
Caroline Siavichay	
PROJECT	Heal Harm Protect
CLIENT	National Museum of Ireland
DATE	12.06.23
GRAPHIC TYPE	AV4
GRAPHIC NO.	03A.01.GR06
SCALE	
NOTES	
KEY PLAN	
	
PAGE NO.	
22	 School of Graduate Studies

Birth

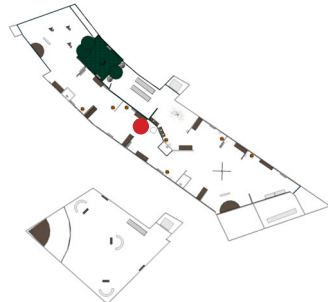

Keeping the Fairies Away

Birth is the second space that is meant to feel as though it is the interior of a home. After entering through a golden archway of trees, visitors will see limestone-washed walls. Hanging from the ceiling will be golden branch chandeliers, meant to symbolize the peat and rush torches traditionally used to light homes. There will be a well that visitors can pull water from which activates a small magical light show on the water. They will also see large stone panels with main quotes/pull out facts cut into the stone. These quotes/facts will be backlit in a way that makes them seem to flicker like a fire in a stone hearth. There will also be content info graphic panels shaped like rounded windows on the walls. These give in depth information about the customs and beliefs related to the artifacts on display. There will also be display cases with artifacts related to birth and childbearing. On the back wall inside the display case, there will be projected silhouettes interacting with the artifacts. Visitors will also be able to view special related items collected from the local community and hear first hand accounts about them. They will also be able to record their own stories in the Fireside Seanchai booths. The overall atmosphere is cozy and communal with a vein of magical mystery running through it.



 Heal Harm Protect	
Caroline Siavichay	
PROJECT	Heal Harm Protect
CLIENT	National Museum of Ireland
DATE	12.06.23
GRAPHIC TYPE	
GRAPHIC NO.	
SCALE	
NOTES	
KEY PLAN 	
PAGE NO.	
23	 School of Graduate Studies

Festival

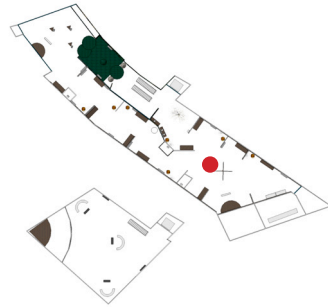

Fire Festivals

Festival is the third space that is meant to feel as though it is the interior of a home. After entering through a golden archway of trees, visitors will see limestone-washed walls. Hanging from the ceiling will be golden branch chandeliers, meant to symbolize the peat and rush torches traditionally used to light homes. There will be another performance area with projection mapping. There will also be a wall of peppers ghost illusions showing both the ordinary and magical uses of common objects. They will also see large stone panels with main quotes/pull out facts cut into the stone. These quotes/facts will be backlit in a way that makes them seem to flicker like a fire in a stone hearth. There will also be content info graphic panels shaped like rounded windows on the walls. These give in depth information about the customs and beliefs related to the artifacts on display. There will also be display cases with artifacts related to the 4 fire festivals - Imbolc, Beltane, Lughnasadh and Samheine. On the back wall inside the display case, there will be projected silhouettes interacting with the artifacts. There will also be a special display case meant to mimic the shape and decoration of a maypole, an important object from the Beltane festival. Visitors will also be able to view special related items collected from the local community and hear first hand accounts about them. They will also be able to record their own stories in the Fireside Seanchai booth. The overall atmosphere is cozy and communal with a vein of magical mystery running through it.



 Heal Harm Protect	
Caroline Siavichay	
PROJECT	Heal Harm Protect
CLIENT	National Museum of Ireland
DATE	12.06.23
GRAPHIC TYPE	
GRAPHIC NO.	
SCALE	
NOTES	
KEY PLAN 	
PAGE NO.	
24	 School of Graduate Studies

Death

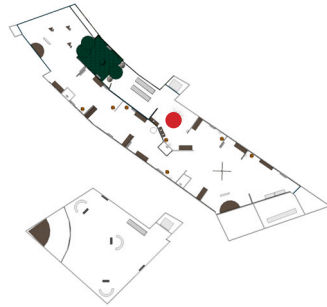

A Wish in the Wind

Death is the final space that is meant to feel as though it is the interior of a home. After entering through a golden archway of trees, visitors will see limestone-washed walls. Hanging from the ceiling will be golden branch chandeliers, meant to symbolize the peat and rush torches traditionally used to light homes. They will also see large stone panels with main quotes/pull out facts cut into the stone. These quotes/facts will be backlit in a way that makes them seem to flicker like a fire in a stone hearth. There will also be content info graphic panels shaped like rounded windows on the walls. These give in depth information about the customs and beliefs related to the artifacts on display. There will also be display cases with artifacts related to illness, death and grieving. On the back wall inside the display case, there will be projected silhouettes interacting with the artifacts. The main activity will be the Wishing Tree. There will be a large recreation of an autumnal tree and several writing stations. At the writing stations, there will be small paper cards with ribbons attached, markers, and directive graphics that instruct visitors to use the materials to write down their wishes and then hang them on one of the tree branches. There is also an interactive screen that allows visitors to input their wishes digitally. These digital wishes will then be projected on the wall as though they are being carried in the wind. The overall atmosphere is cozy and communal with a vein of magical mystery running through it.

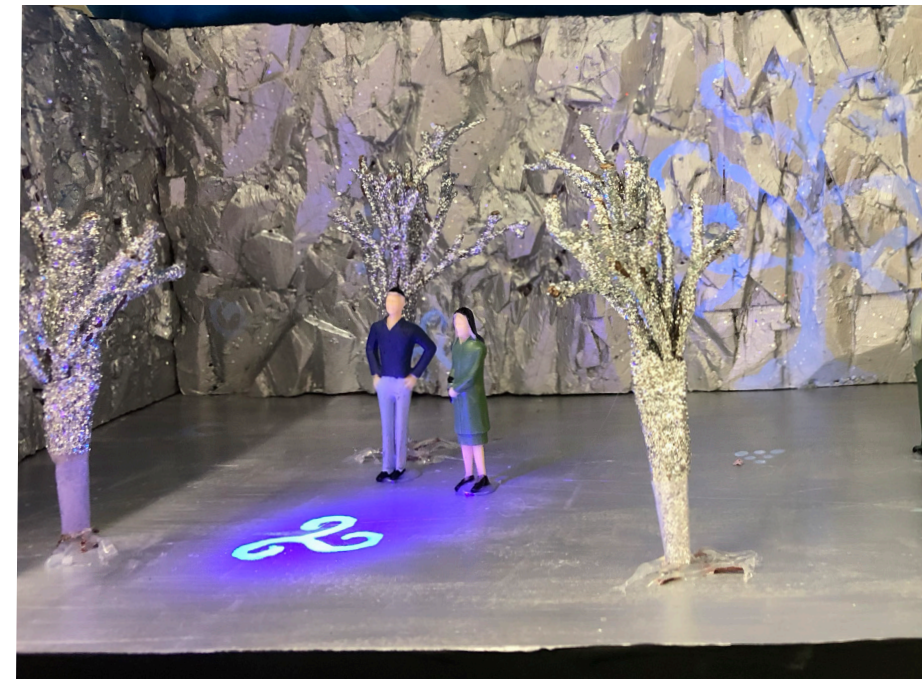
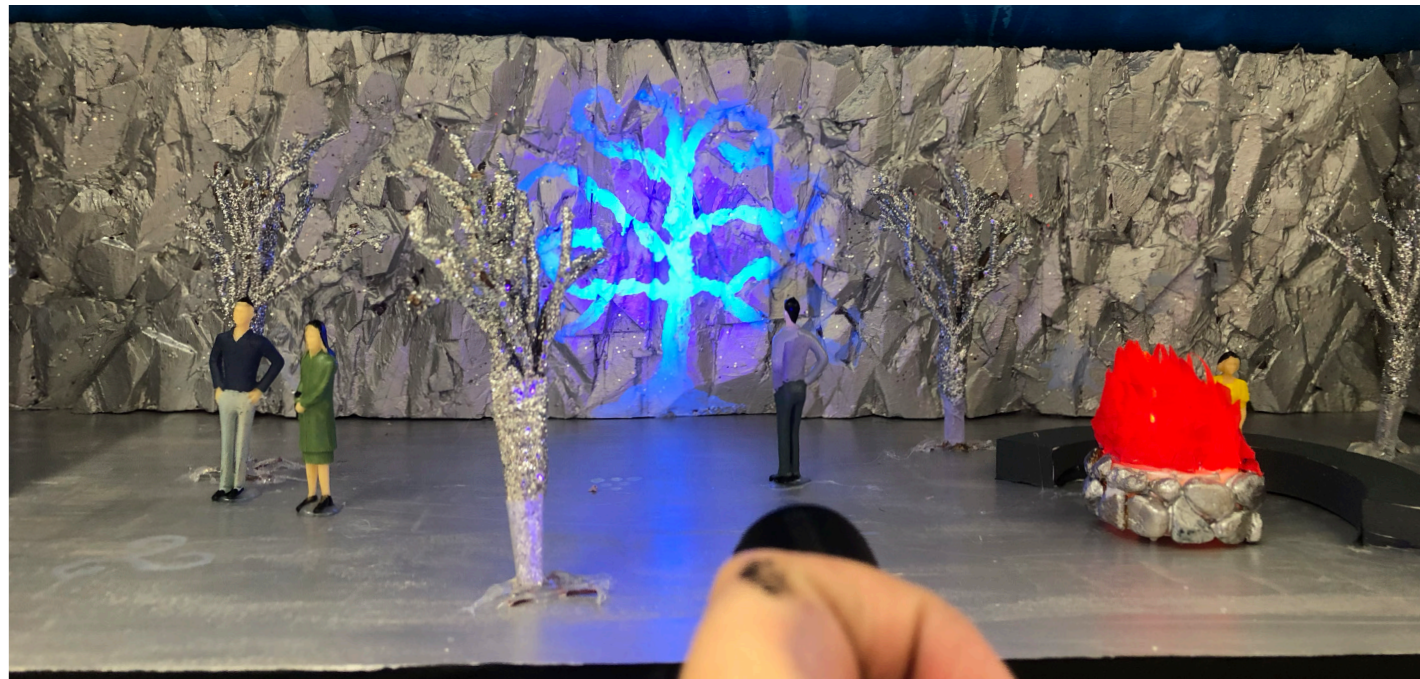
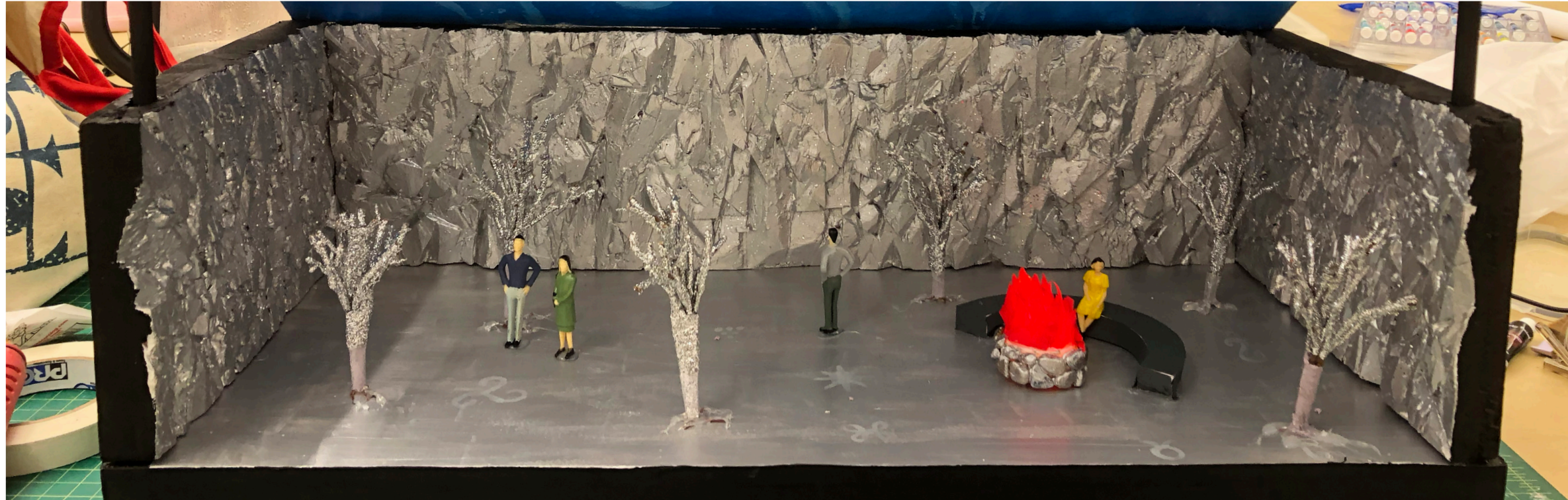

 Heal Harm Protect	
Caroline Siavichay	
PROJECT	Heal Harm Protect
CLIENT	National Museum of Ireland
DATE	12.06.23
GRAPHIC TYPE	
GRAPHIC NO.	
SCALE	
NOTES	
KEY PLAN 	
PAGE NO.	
25	 School of Graduate Studies

The Otherworld

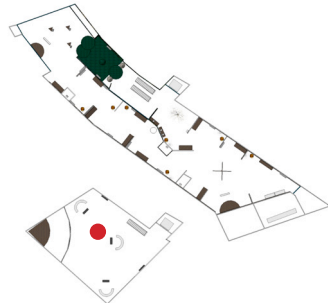

Beyond the Veil

The Otherworld is situated on a lower level than the rest of the exhibition. Upon entry visitors will see silver glittering rock walls and trees and a silver glittering carpet, as well as content information graphics that teach them about the storied history of the Otherworld and the practice of divination used to decipher messages from the fairies and ghosts who reside there. There will also be bins with small UV flashlights and directive graphics instructing visitors to take one. Attached to the end of each flashlight is a card that shows multiple Irish symbols that are hidden in UV paint around the area. Visitors are instructed to use their UV flashlights to find the hidden symbols, then use their cards to “decipher the messages” left for them through the hidden symbols. There is also a walled off performance area where visitors will experience one last traditional Irish folktale performance with interactive projection mapping. This is the most experiential space of the exhibition and has an atmosphere of otherworldly fantasy.



 Heal Harm Protect	
Caroline Siavichay	
PROJECT	Heal Harm Protect
CLIENT	National Museum of Ireland
DATE	12.06.23
GRAPHIC TYPE	
GRAPHIC NO.	
SCALE	
NOTES	
KEY PLAN 	
PAGE NO.	
26	 School of Graduate Studies



Schedules & Lists

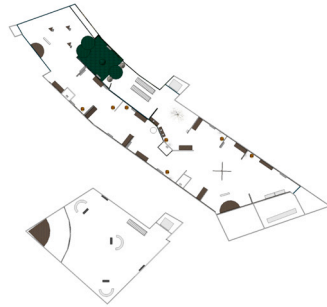

Graphic Schedule

GRAPHIC #	SPEC #	DESCRIPTION	GRAPHIC #	SPEC #	DESCRIPTION
01A.01.GR01	F	Open Countryside	03A.01.GR07	D	Fireside Seanchai
01A.01.GR02	F	Open Village Countryside	03A.01.GR08	AV4	Marriage Share A Story
01A.01.GR03	G	Indoor Wayfinding	03A.01.GR09	D	Content Info & Photos
01A.01.GR04	A	Intro Info Panel	03A.01.GR10	D	Quote/Streaker Fact Panel
01A.01.GR05	B	Welcome Sign	03A.01.GR11	D	Quote/Streaker Fact Panel
02A.01.GR01	AV1	Fairy Path Digital Flooring	03A.01.GR12	D	Content Info & Photos
02A.01.GR02	D	Quote/Streaker Fact Panel	03A.01.GR13	AV3	Silhouette Projection
02A.01.GR03	D	Content Info & Photos	03A.01.GR14	D	Label Rail
02A.01.GR04	D	Content Info & Photos	03A.01.GR15	D	Quote/Streaker Fact Panel
02A.01.GR05	D	Quote/Streaker Fact Panel	03A.01.GR16	E	Community Object Directive
02A.02.GR01	D	Motion Sensor Reveal Wall	03A.01.GR17	E	Birth Well Directive
02A.02.GR02	E	Buried Object Directive	03A.01.GR18	F	House Yard Mural
02A.02.GR03	E	Buried Object Directive	03A.01.GR19	E	Community Object Directive
02A.02.GR04	AV3	Foundation Drawings	03A.01.GR20	AV3	Silhouette Projection
02A.02.GR05-07	D	Small Info Label	03A.01.GR21	D	Label Rail
02A.02.GR08	AV4	Foundation Drawing Activity	03A.01.GR22	D	Content Info & Photos
02A.02.GR09-11	D	Small Info Label	04A.01.GR01	C	Birth Area Intro
02A.02.GR12	AV4	Foundation Drawing Activity	04A.01.GR02	E	Community Object Directive
02A.02.GR13-15	D	Small Info Label	04A.01.GR03	D	Content Info & Photos
02A.02.GR16	AV4	Foundation Drawing Activity	04A.01.GR04	D	Quote/Streaker Fact Panel
02A.02.GR17	AV3	Story 1 Projection Mapping	04A.01.GR05	D	Quote/Streaker Fact Panel
03A.01.GR01	C	Marriage Area Intro	04A.01.GR06	D	Content Info & Photos
03A.01.GR02	D	Quote/Streaker Fact Panel	04A.01.GR07	AV3	Silhouette Projection
03A.01.GR03	D	Content Info & Photos	04A.01.GR08	D	Label Rail
03A.01.GR04	D	Content Info & Photos	04A.01.GR09	D	Label Rail
03A.01.GR05	AV3	Silhouette Projection	04A.01.GR10	AV3	Silhouette Projection
03A.01.GR06	D	Label Rail	04A.01.GR11	F	Open Village Countryside

 Heal Harm Protect	
Caroline Siavichay	
PROJECT	Heal Harm Protect
CLIENT	National Museum of Ireland
DATE	12.06.23
GRAPHIC TYPE	
GRAPHIC NO.	
SCALE	
NOTES	
KEY PLAN 	
PAGE NO.	 School of Graduate Studies
28	

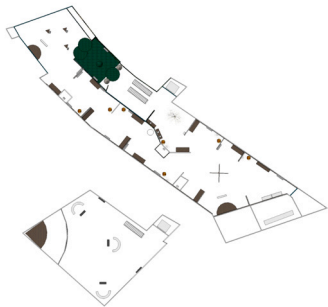

Graphic Schedule

GRAPHIC #	SPEC #	DESCRIPTION	GRAPHIC #	SPEC #	DESCRIPTION
04A.01.GR12	E	Birth Well Directive	05A.01.GR17	D	Content Info & Photos
04A.01.GR13	D	Quote/Streaker Fact Panel	05A.01.GR18	E	Community Object Directive
04A.01.GR14	D	Content Info & Photos	05A.01.GR19	AV3	Silhouette Projection
04A.01.GR15	AV3	Silhouette Projection	05A.01.GR20	D	Label Rail
04A.01.GR16	D	Label Rail	05A.01.GR21	D	Content Info & Photos
04A.01.GR17	D	Content Info & Photos	05A.01.GR22	D	Quote/Streaker Fact Panel
04A.01.GR18	AV4	Birth Share A Story Screen	06A.01.GR01	C	Death Area Intro
04A.01.GR19	D	Fireside Seanchai	06A.01.GR02	AV3	Silhouette Projection
04A.01.GR20	D	Content Info & Photos	06A.01.GR03	D	Label Rail
04A.01.GR21	D	Quote/Streaker Fact Panel	06A.01.GR04	E	Community Object Directive
04A.01.GR22	E	Community Object Directive	06A.01.GR05	D	Quote/Streaker Fact Panel
05A.01.GR01	C	Festival Area Intro	06A.01.GR06	AV3	Silhouette Projection
05A.01.GR02	F	Beltane Field Mural	06A.01.GR07	D	Label Rail
05A.01.GR03	D	Fireside Seanchai	06A.01.GR08	D	Content Info & Photos
05A.01.GR04	AV4	Festival Share A Story Screen	06A.01.GR09	E	Community Object Directive
05A.01.GR05	D	Content Info & Photos	06A.01.GR10	E	Wishing Tree Directive
05A.01.GR06	D	Content Info & Photos	06A.01.GR11	E	Wishing Tree Directive
05A.01.GR07	D	Label Rail	06A.01.GR12	AV4	Wishing Tree Screen
05A.01.GR08	AV3	Silhouette Projection	06A.01.GR13	AV3	Wish Wind Wall
05A.01.GR09	AV3	Story 2 Projection Mapping	06A.01.GR14	D	Content Info & Photos
05A.01.GR10	D	Content Info & Photos	07A.01.GR01	D	Content Info & Photos
05A.01.GR11	D	Content Info & Photos	07A.01.GR02	E	Otherworld UV Directive
05A.01.GR12	D	Content Info & Photos	07A.01.GR03	D	Quote/Streaker Fact Panel
05A.01.GR13	D	Content Info & Photos	07A.01.GR04	D	Content Info & Photos
05A.01.GR14	G	Indoor Wayfinding	07A.01.GR05	E	Otherworld UV Directive
05A.01.GR15	D	Quote/Streaker Fact Panel	07A.01.GR06	D	Quote/Streaker Fact Panel
05A.01.GR16	E	Peppers Ghost Wall Directive			

	
Caroline Siavichay	
PROJECT	Heal Harm Protect
CLIENT	National Museum of Ireland
DATE	12.06.23
GRAPHIC TYPE	
GRAPHIC NO.	
SCALE	
NOTES	
<p>KEY PLAN</p> 	
PAGE NO.	
29	

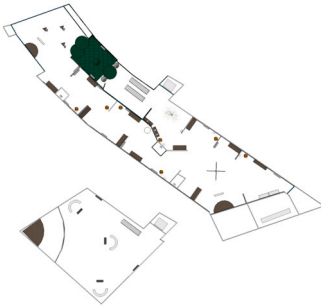

Graphic Schedule

GRAPHIC #	SPEC #	DESCRIPTION
08A.01.GR01	G	Exterior Wayfinding Installation
08A.01.GR02	G	Exterior Wayfinding Installation
08A.01.GR03	G	Exterior Wayfinding Installation
08A.01.GR04	G	Exterior Wayfinding Installation
08A.01.GR05	G	Exterior Wayfinding Installation
08A.01.GR06	G	Exterior Wayfinding Installation
08A.01.GR07	G	Exterior Wayfinding Installation
08A.01.GR08	G	Exterior Wayfinding Installation
08A.01.GR09	G	Exterior Wayfinding Installation



 Heal Harm Protect	
Caroline Siavichay	
PROJECT	Heal Harm Protect
CLIENT	National Museum of Ireland
DATE	12.06.23
GRAPHIC TYPE	
GRAPHIC NO.	
SCALE	
NOTES	
<p>KEY PLAN</p> 	
PAGE NO.	 School of Graduate Studies
30	

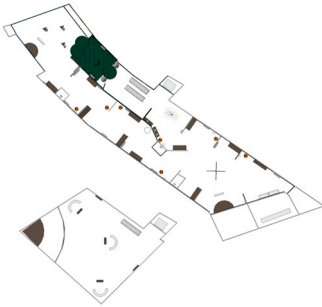

Graphic Specs

Type	Description
A	High resolution ink jet print mounted to 1/4" sintra with overlamination, print to wrap returns
B	Custom wrought iron
C	Screen print on 2" frosted acrylic
D	High resolution ink jet print mounted to 2" sintra with overlamination, print to wrap returns
E	Screen print on metallic vinyl
F	High resolution ink jet print on vinyl with overlamination, matte
G	Frosted blue glass with custom interior gold lettering, lit internally

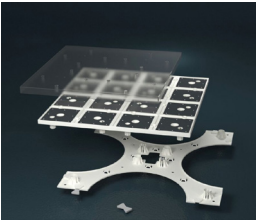
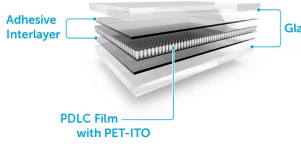
	
Caroline Siavichay	
PROJECT	Heal Harm Protect
CLIENT	National Museum of Ireland
DATE	12.06.23
GRAPHIC TYPE	
GRAPHIC NO.	
SCALE	
NOTES	
<p>KEY PLAN</p> 	
PAGE NO.	
31	

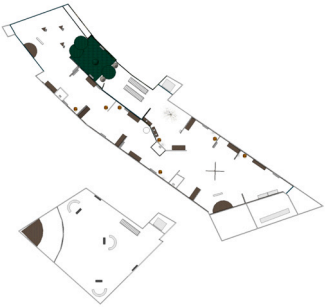

AV Schedule

Type	Code	Description	Manufacturer	Image
AV1	AV1.01	Interactive LED sensor flooring	Sensacell	
AV2	AV2.01	Motion sensor smart glass	Gauzy	
AV3	AV3.01 AV3.02 AV3.03 AV3.04 AV3.05 AV3.06	Laser Projector	Optoma	
AV4	AV4.01 AV4.02 AV4.03 AV4.04 AV4.05	15.5" Touch Screen	Elo	

 Heal Harm Protect	
Caroline Siavichay	
PROJECT	Heal Harm Protect
CLIENT	National Museum of Ireland
DATE	12.06.23
GRAPHIC TYPE	
GRAPHIC NO.	
SCALE	
NOTES	
KEY PLAN 	
PAGE NO.	
32	 School of Graduate Studies

Material Schedule

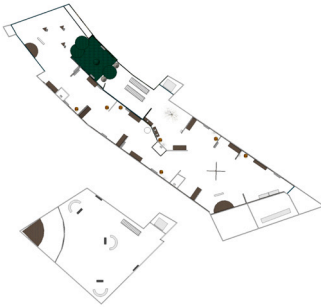
Material	Code	Area	Description
Carpet	M01	01A - 06A	Rose Brand Event Carpet, Royal Blue,(or equivalent)
	M02	07A	Rose Brand Glitter Event Carpet, Silver (or equivalent)
Stone	M03	01A	Stacked field stone with mortar
Wallpaper	M04	02A - 06A	Modern Limewash Wallpaper. Timberlea Interiors
	M05	03A - 05A	Distressed red brick peel and stick, Home Depot
	M14	07A	Metallic Silver forest wallpaper, Lionheart Wallpaper
Iron	M06	01A	Custom wrought iron sign "Cead Mile Failte"
Wood	M07	01A - 07A	Frame flats dry walled with a #5 plaster finish
	M12	02A - 06A	Dyke's 253 back band moulding
	M15	01A - 07A	Dyke's 424 base moulding
	M19	02A, 05A, 07A	Wood veneer pressed plywood
Metal	M08	03A - 06A	Metallic gold powder coated stainless steel
Plastic	M09	06A	Custom cast plastic tree
	M10	07A	Vacuform plastic stone texture tiled wall application
	M18	07A	Vacuform plastic stone campfire base
Paper	M11	01A - 06A	Procedes Chenel paper ceiling drop stripe
Acrylic	M13	01A - 07A	1/2" frosted acrylic sheet
Paint	M16	02A, 05A	Colourtrend Ceramic Matt in Christmas Wreath
	M17	07A	Colourtrend Ceramic Matt in Dolmen
	M18	07A	Dulux Duramax Metalli Silver Finish

 Heal Harm Protect	
Caroline Siavichay	
PROJECT	Heal Harm Protect
CLIENT	National Museum of Ireland
DATE	12.06.23
GRAPHIC TYPE	
GRAPHIC NO.	
SCALE	
NOTES	
KEY PLAN 	
PAGE NO.	 School of Graduate Studies
33	

Material Plan

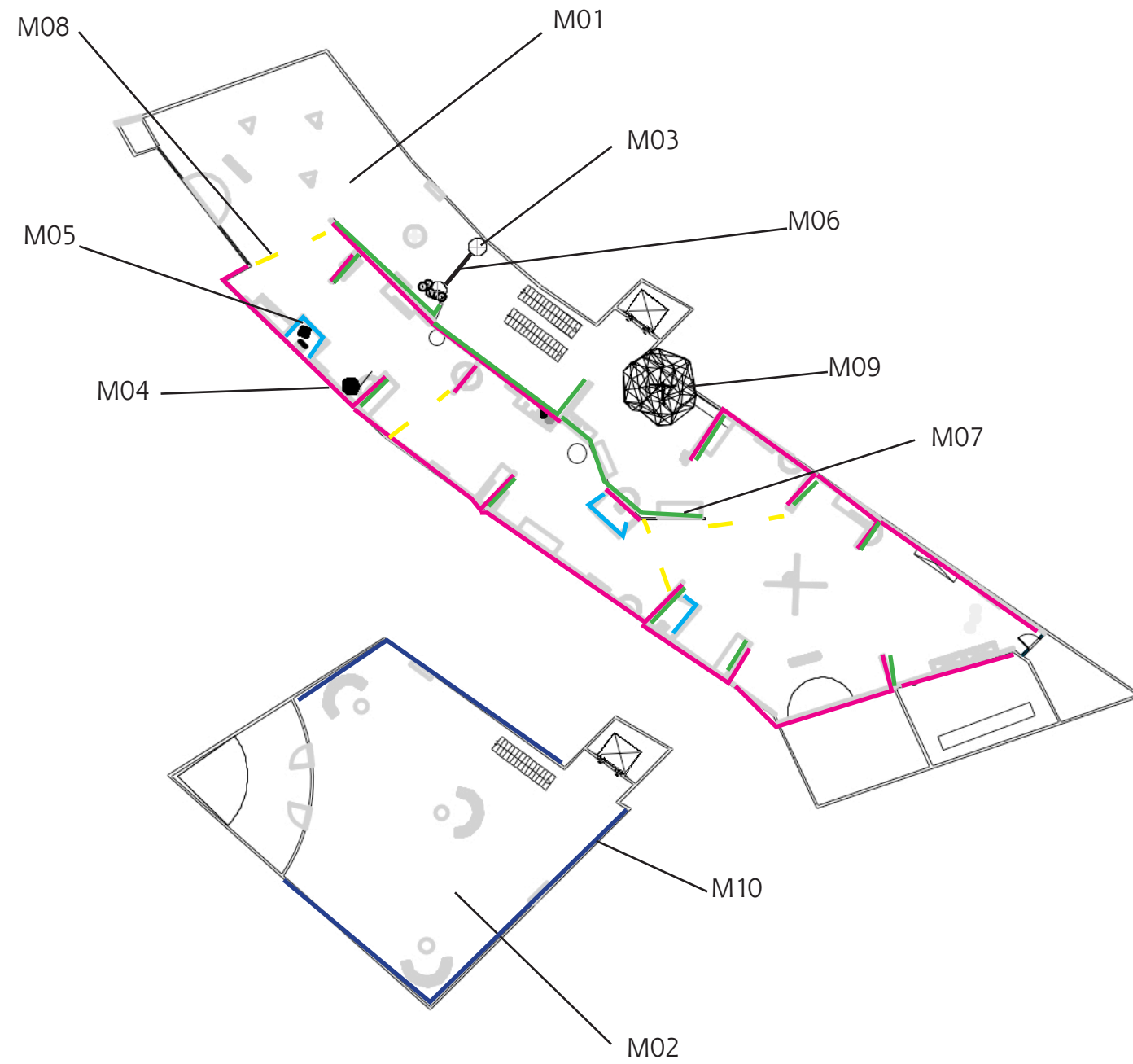

Caroline Siavichay

PROJECT Heal Harm Protect

CLIENT National Museum of Ireland

DATE 12.06.23

GRAPHIC TYPE

GRAPHIC NO.

SCALE

NOTES

KEY PLAN

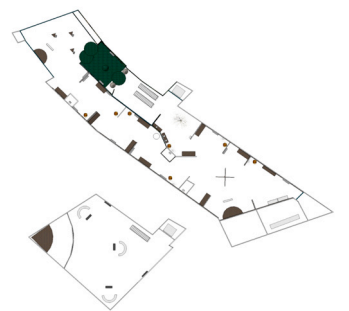

PAGE NO.



34

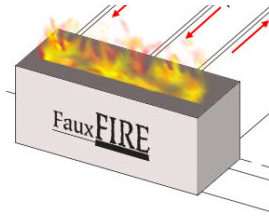

School of Graduate Studies

Lighting Schedule

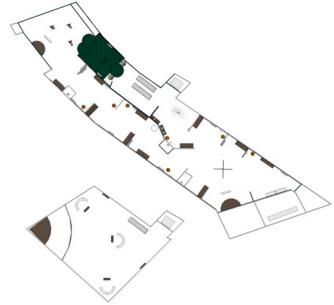
Name	Description	Manufacturer	Image
T1	Track mouted spot	existing in space	
T2	Recessed downlights	existing in space	
C1	Golden Branch Chandelier	Balder Lighting	
J1	LED Mini track spotlights	Elumalight	
G1	Maverick Silens 2 Water Gobo	Chauvet	
G2	Well Gobo Fire Effect	Chauvet	
FX1	FauxFire LED and Steam	Technifex	

 Heal Harm Protect	
Caroline Siavichay	
PROJECT	Heal Harm Protect
CLIENT	National Museum of Ireland
DATE	12.06.23
GRAPHIC TYPE	
GRAPHIC NO.	
SCALE	
NOTES	
KEY PLAN 	
PAGE NO.	
35	 School of Graduate Studies

Artifact List

BUILDING A VILLAGE

- A1.01 Horse Skull
- A1.02 Saint Anthony Medal
- A1.03 Statuette
- A1.04 Assortment of silver coins
- A1.05 Clay pipe
- A1.06 Shoe
- A1.07 Saint Joseph Medal
- A1.08 Saint Brigid Medal
- A1.09 Holy water vial

MARRIAGE

- A2.01 Hope chest
- A2.02 Chair
- A2.03 Lace veil
- A2.04 Handkerchief
- A2.05 Handkerchief
- A2.06 Handkerchief
- A2.07 Bridal shoes
- A2.08 Collection of sixpence
- A2.09 Table
- A2.10 Ceramic dish set
- A2.11 Horseshoe
- A2.12 Horseshoe
- A2.13 Handfasting cord
- A2.14 Goblet set
- A2.15 Wedding bell
- A2.16 Embroidery
- A2.17 Lace doily
- A2.18 Grooms shoes
- A2.19 Costmetics case
- A2.20 Vintage whiskey bottle

BIRTH

- A3.01 Iron tongs
- A3.02 Cradle
- A3.03 Red ribbon
- A3.04 Wooden night stand
- A3.05 Tin pitcher
- A3.06 Ceramic butter dish
- A3.07 Candle holder
- A3.08 Iron charm
- A3.09 Wooden chair
- A3.10 Rosary beads
- A3.11 Rosary beads
- A3.12 Rosary beads
- A3.13 Tin bucket
- A3.14 Shovel
- A3.15 Blanket
- A3.14 Holy water vial
- A3.15 Butter churn
- A3.16 St. Brigids Cloak
- A3.17 Man's shirt
- A3.18 Butter print

FESTIVAL

- A4.01 Hearth tool set
- A4.02 St. Brigid's Cross
- A4.03 St. Brigid's Cross
- A4.04 Bridie Doll
- A4.05 Bread box
- A4.06 Maypole ribbons
- A4.07 Girl's dress
- A4.08 Goblet set
- A4.09 Torch
- A4.10 Plow
- A4.11 Hoe
- A4.12 Rake
- A4.13 Feed bag
- A4.14 Feeding trough
- A4.15 Grinding stone
- A4.16 Mortar and pestle
- A4.17 Scythe

FESTIVAL (CONT'D)



- A4.19 Turnip lantern
- A4.20 Samhein mask
- A4.21 Samhein mask
- A4.22 Samhein mask
- A4.23 Chestnut necklace
- A4.24 Rosehip necklace
- A4.25 Children's conkers
- A4.26 Bairin breac ring
- A4.27 Bairin breac ring
- A4.28 Candle holder
- A4.29 Hallowe'en cross
- A4.30 Hallowe'en cross

DEATH

- A5.01 Straw mat
- A5.02 Hearth tool set
- A5.03 Candle holder
- A5.04 Crucifix
- A5.05 Crucifix
- A5.06 Milk pail
- A5.06 Milk pitcher
- A5.07 Clock
- A5.08 Mirror
- A5.09 Grieving veil
- A5.10 Chair
- A5.11 Bee keeping tools
- A5.12 Hive box
- A5.13 Rosary beads
- A5.14 Cloughtie
- A5.15 Holy water vial

COMMUNITY SOURCED

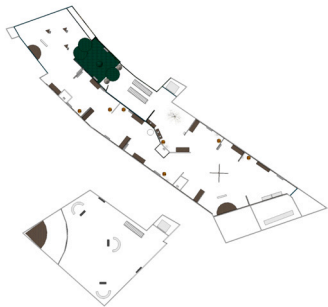
- A6.01 Wedding dress
- A6.02 Saffron kilt and uilleann pipes
- A6.03 Christening dress and bonnet
- A6.04 Baby blanket
- A6.05 Homemade samhein costume
- A6.06 Journal and handwritten letter

 Heal Harm Protect	
Caroline Siavichay	
PROJECT	Heal Harm Protect
CLIENT	National Museum of Ireland
DATE	12.06.23
GRAPHIC TYPE	
GRAPHIC NO.	
SCALE	
NOTES	
<p>KEY PLAN</p> 	
PAGE NO.	 School of Graduate Studies
36	

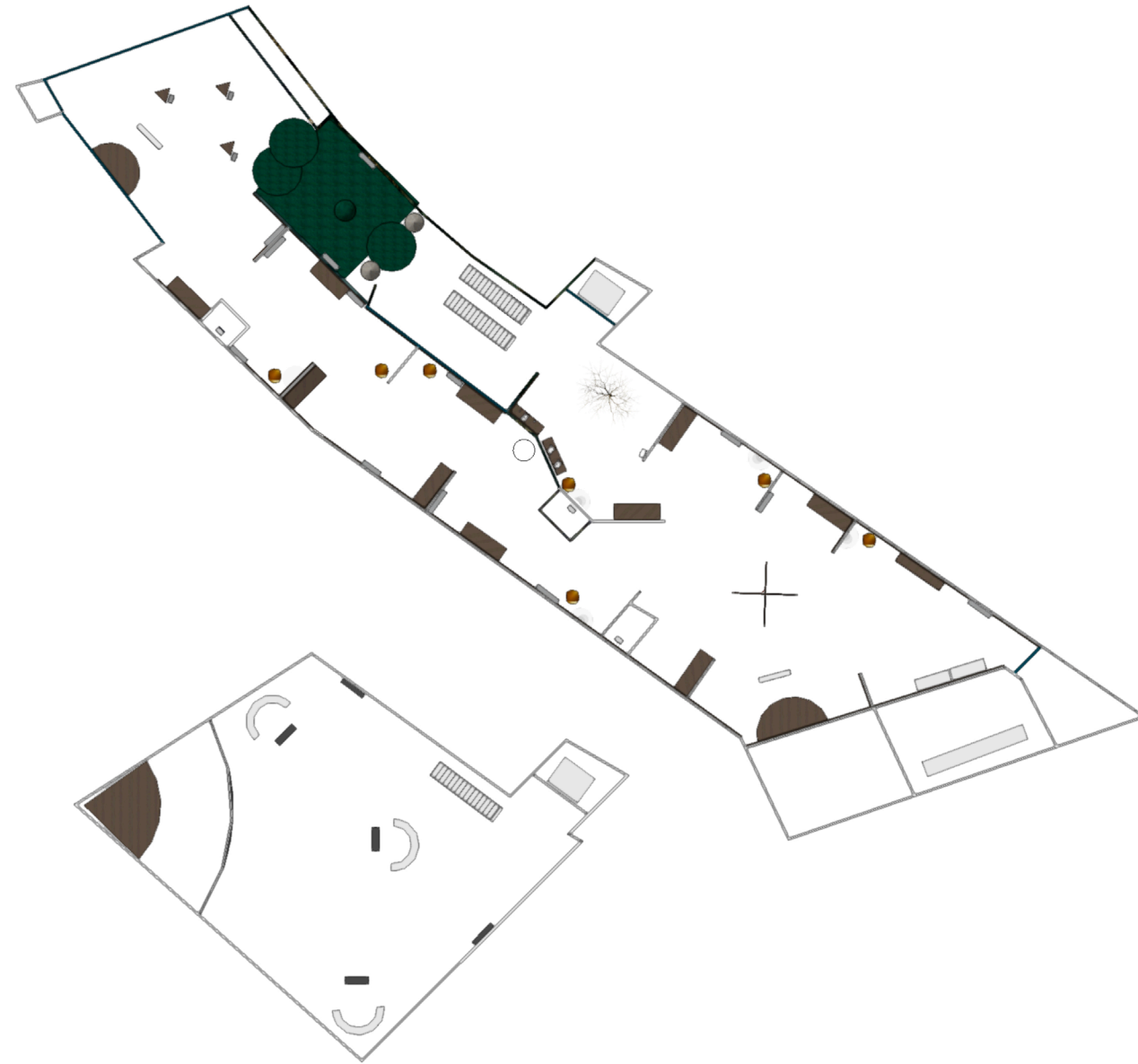

1 Level C & D Plan
Scale: 1/32" = 1'-0"



Caroline Siavichay

PROJECT Heal Harm Protect

CLIENT National Museum of Ireland

DATE 12.06.23

GRAPHIC TYPE

GRAPHIC NO.

SCALE

NOTES

KEY PLAN

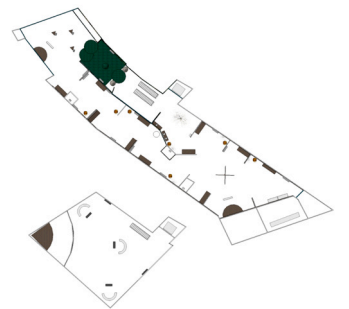

PAGE NO.



37

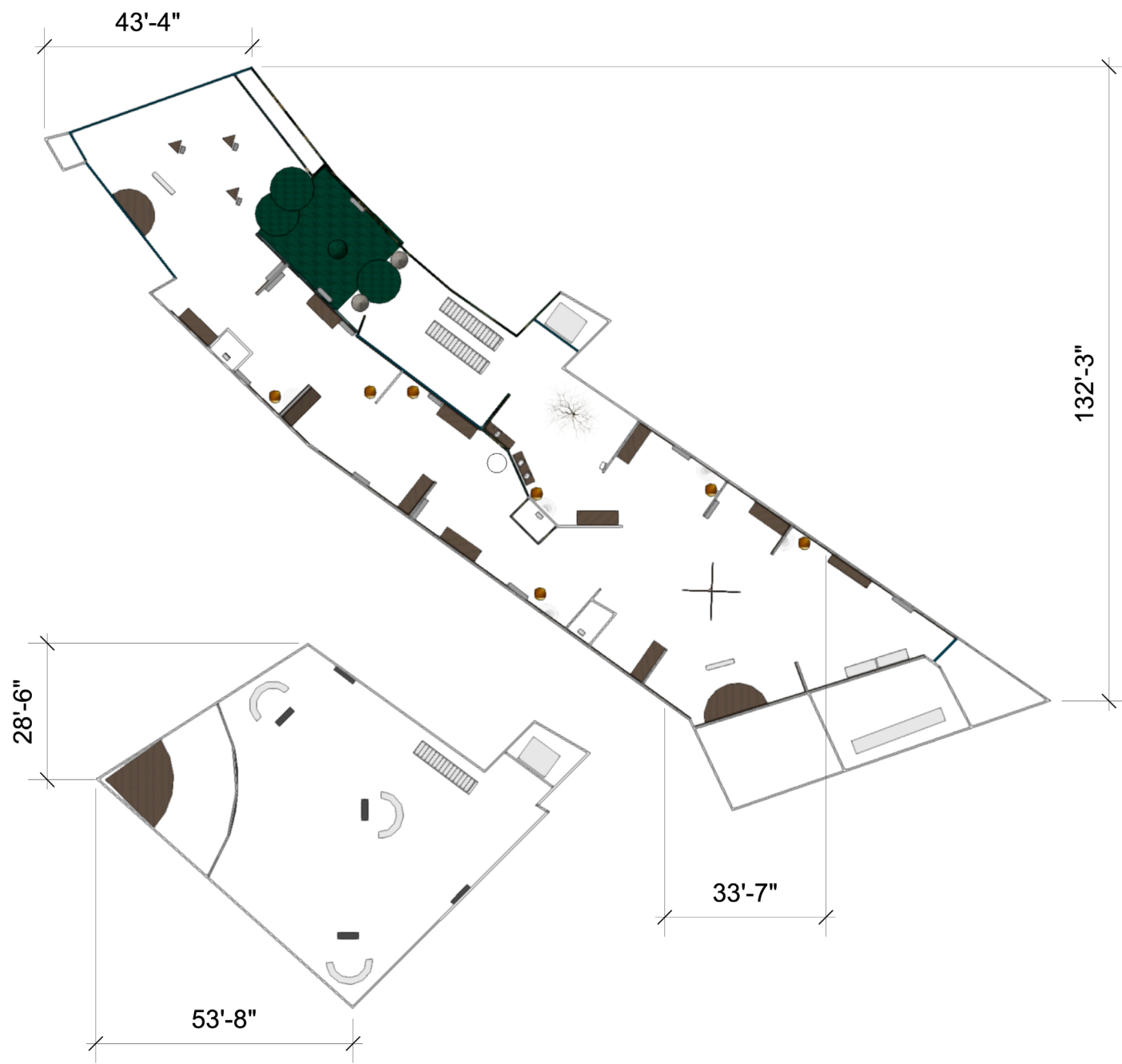

School of Graduate Studies



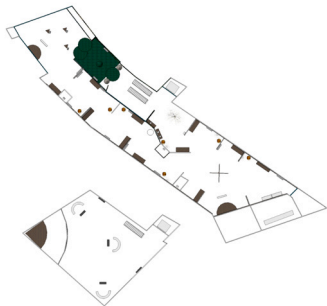

1 Dimension Plan
 Scale: 1/32" = 1'-0"

 Heal Harm Protect	
Caroline Siavichay	
PROJECT	Heal Harm Protect
CLIENT	National Museum of Ireland
DATE	12.06.23
GRAPHIC TYPE	
GRAPHIC NO.	
SCALE	
NOTES	
KEY PLAN	
PAGE NO.	 School of Graduate Studies
38	

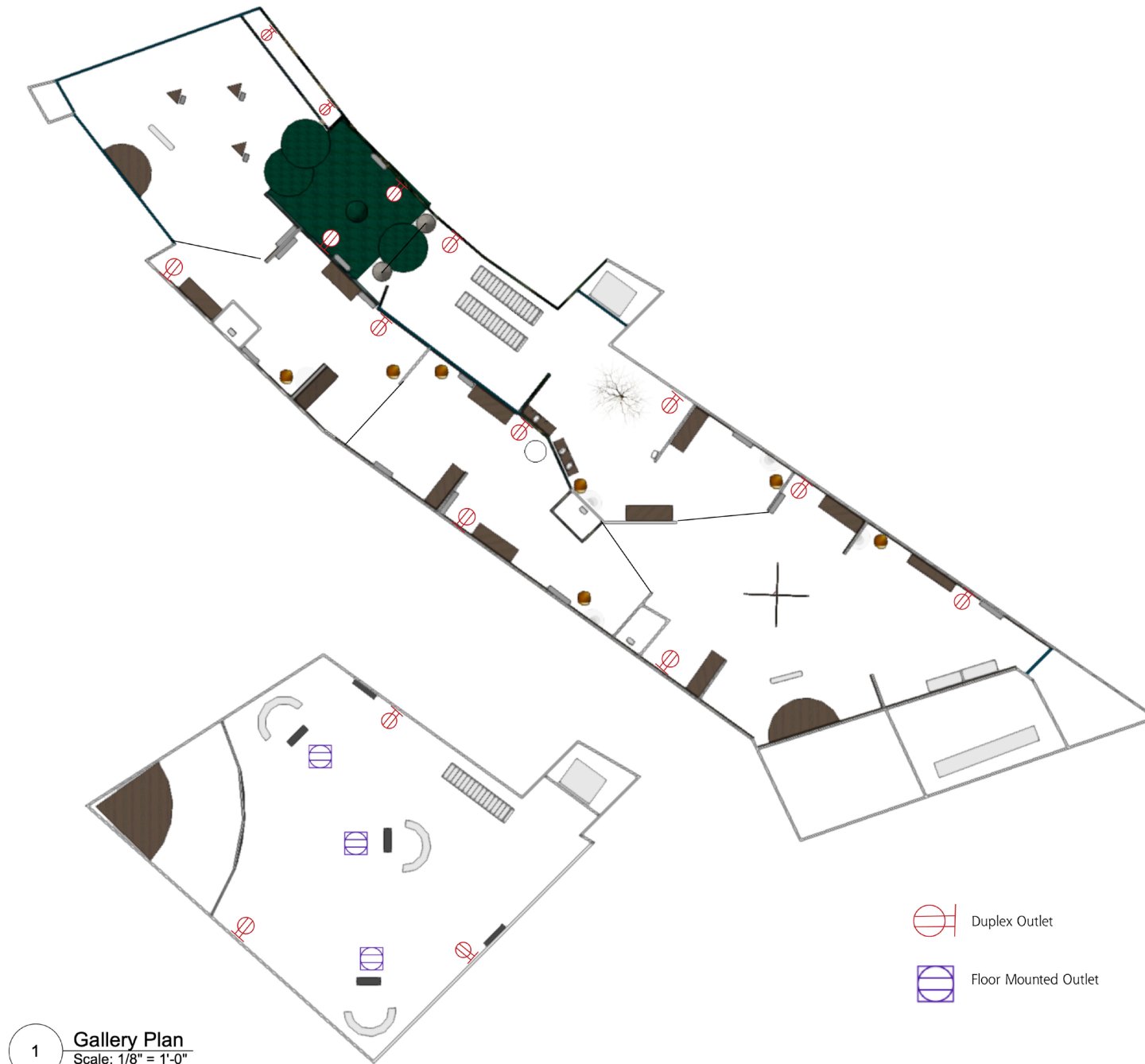
Power & Data Plan

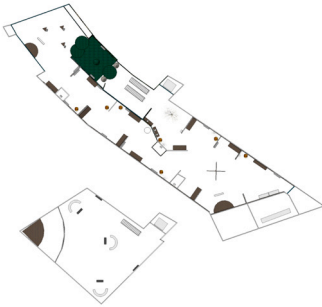

1 Gallery Plan
Scale: 1/8" = 1'-0"

 Heal Harm Protect	
Caroline Siavichay	
PROJECT	Heal Harm Protect
CLIENT	National Museum of Ireland
DATE	12.06.23
GRAPHIC TYPE	
GRAPHIC NO.	
SCALE	
NOTES	- Not to scale
KEY PLAN	
PAGE NO.	40
 School of Graduate Studies	

Caroline Siavichay

PROJECT Heal Harm Protect

CLIENT National Museum of Ireland

DATE 12.06.23

GRAPHIC TYPE

GRAPHIC NO.

SCALE

NOTES

KEY PLAN

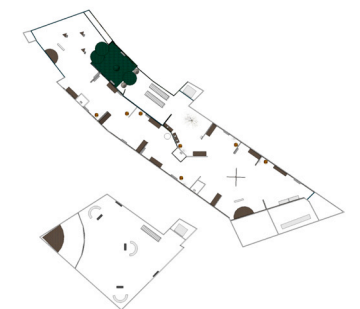

PAGE NO.

41



School of
Graduate Studies

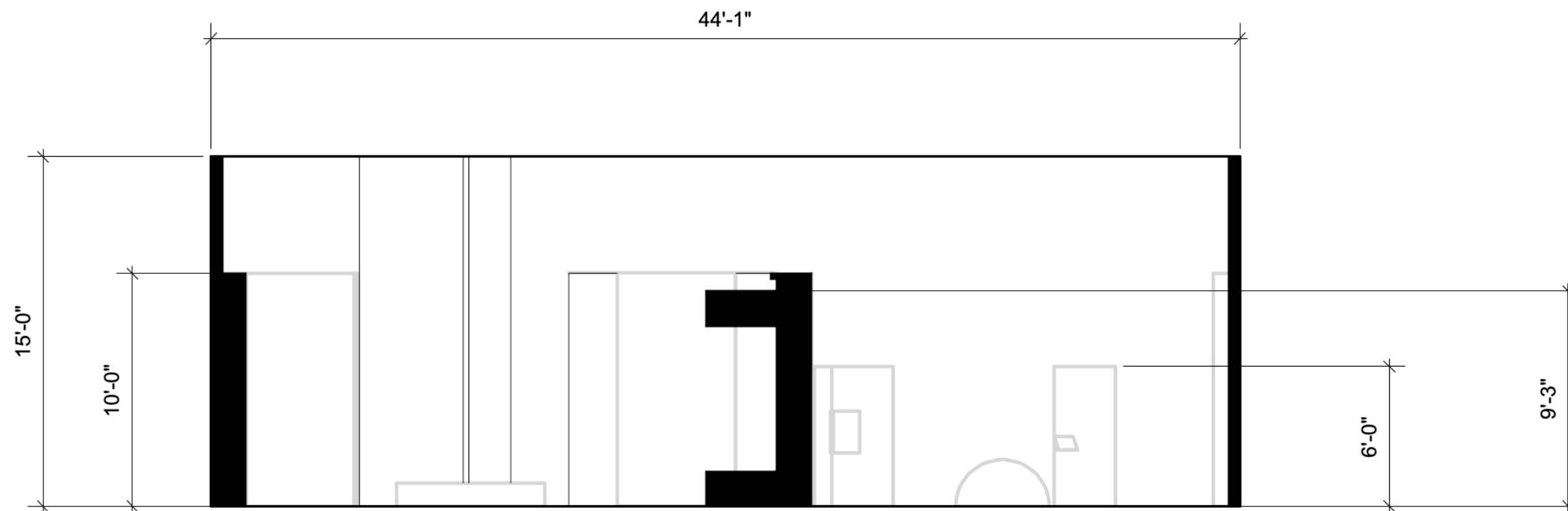

1 **Level C Section**
Scale: 3/16" = 1'-0"

Caroline Siavichay

PROJECT Heal Harm Protect

CLIENT National Museum of Ireland

DATE 12.06.23

GRAPHIC TYPE

GRAPHIC NO.

SCALE

NOTES

KEY PLAN

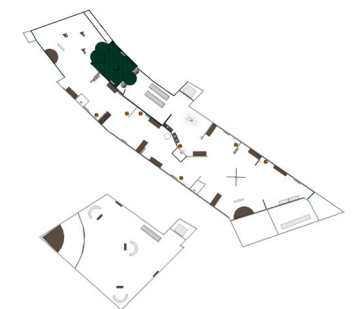

PAGE NO.

42



School of
Graduate Studies

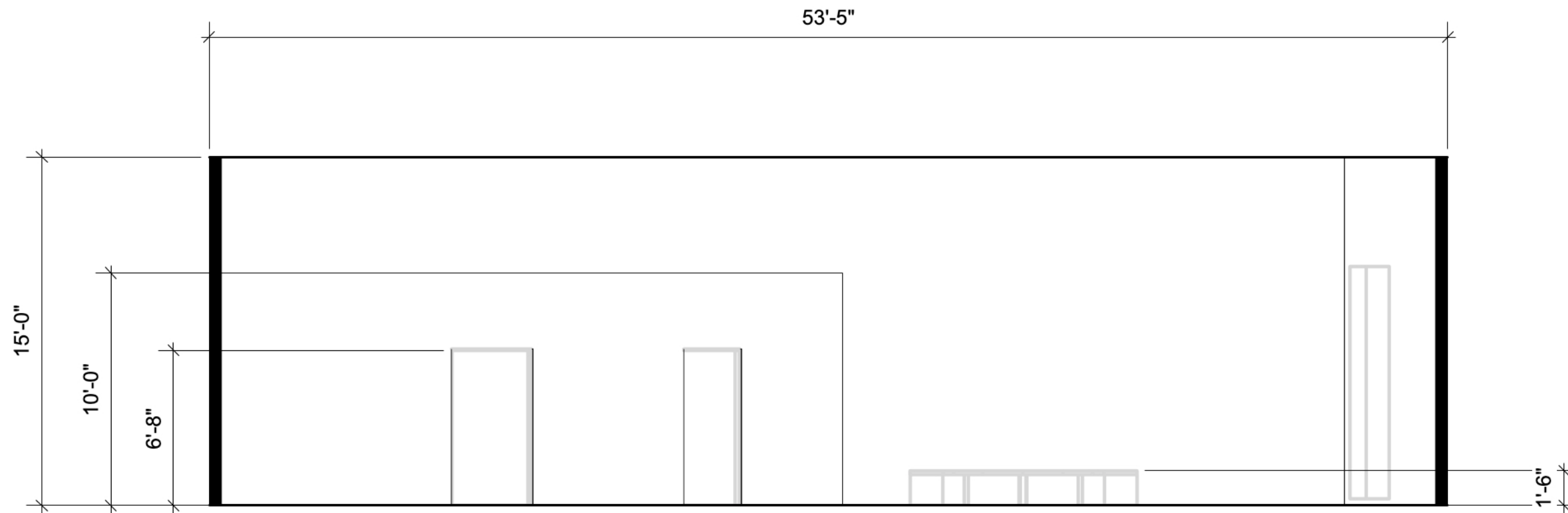

1 Level D Section
Scale: 3/16" = 1'-0"



Graphic Systems

Color Palette & Typography

Eagle Lake

ABCDEFGHIJKLMNOPQRSTUVWXYZ
 abcdefghijklmnopqrstuvwxyz
 1234567890 !@#\$%^&*()

MRS EAVES

ABCDEFGHIJKLMNOPQRSTUVWXYZ

ABCDEFGHIJKLMNOPQRSTUVWXYZ

1234567890 !@#\$%^&*()

Shannon Pro

ABCDEFGHIJKLMNOPQRSTUVWXYZ
 abcdefghijklmnopqrstuvwxyz
 1234567890 !@#\$%^&*()



99-16 C



6126 C



6160 C



DEEP METALLIC GOLD



BLACK 6



1815 C

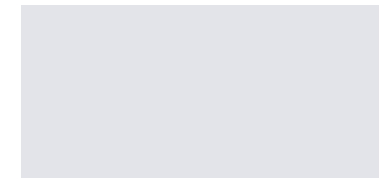

COOL GRAY 1



Caroline Siavichay

PROJECT Heal Harm Protect

CLIENT National Museum of Ireland

DATE 12.06.23

GRAPHIC TYPE

GRAPHIC NO.

SCALE

NOTES

KEY PLAN

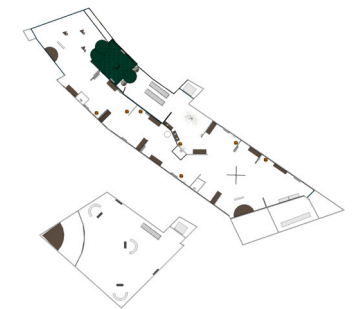

PAGE NO.

44



School of Graduate Studies

Graphic Look & Feel

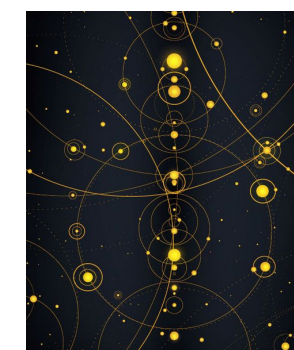

Reference Imagery



Heal
Harm
Protect

Caroline Siavichay

PROJECT Heal Harm Protect

CLIENT National Museum of Ireland

DATE 12.06.23

GRAPHIC TYPE

GRAPHIC NO.

SCALE

NOTES

KEY PLAN

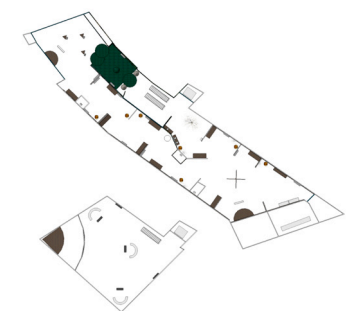

PAGE NO.

45



School of
Graduate Studies

Logo



Heal
Harm
Protect



Heal
Harm
Protect





Heal
Harm
Protect



Heal
Harm
Protect

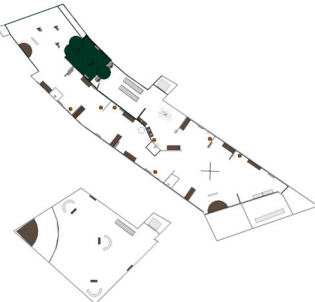

	Heal Harm Protect
Caroline Siavichay	
PROJECT	Heal Harm Protect
CLIENT	National Museum of Ireland
DATE	12.06.23
GRAPHIC TYPE	
GRAPHIC NO.	
SCALE	
NOTES	
KEY PLAN	
PAGE NO.	 School of Graduate Studies
46	

Poster & Marketing Collateral



Caroline Siavichay

PROJECT Heal Harm Protect

CLIENT National Museum of Ireland

DATE 12.06.23

GRAPHIC TYPE

GRAPHIC NO.

SCALE

NOTES

KEY PLAN

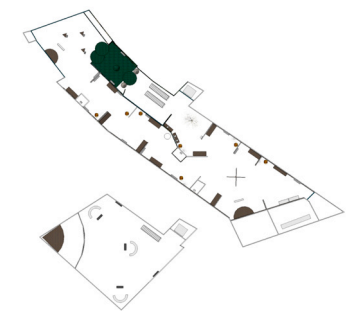

PAGE NO.

47





School of Graduate Studies

Post Engagement Collateral

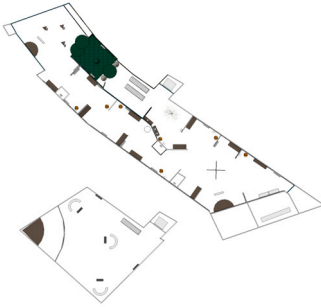

Folk Aid Kit

Visitors will have the option to purchase Folk Aid Kits in the museum gift shop. Each Folk Aid Kit is aimed at a specific day: a wedding, a birth or a holiday. They are small wooden boxes filled with many items that are needed to carry out Irish folk customs and rituals associated with that day. All items in the boxes have been crafted by a local maker/artist.

 Heal Harm Protect	
Caroline Siavichay	
PROJECT	Heal Harm Protect
CLIENT	National Museum of Ireland
DATE	12.06.23
GRAPHIC TYPE	
GRAPHIC NO.	
SCALE	
NOTES	
KEY PLAN	
PAGE NO.	 School of Graduate Studies
48	

Post Engagement Collateral



Winter Solstice Candle

In ancient times, the Winter Solstice, known as Meán Geimhridh (pronounced Mawn G+ev+ree) was one of the darkest and most pivotal times of the year.

From the 19th to the 31st of December, the people of Ireland held the belief that the sun came to a standstill, plunging the world into its darkest nights, but that the flickering flames of a burning log or, in later times, the flame of a candle could influence the sun to resume its course.



Light was sacred during this time, as it meant warmth after the cold of winter, and warmth meant life. Keeping a candle in your window during this dark period also came to serve as a signal that anyone feeling cold, weary, or in need would discover hospitality indoors.

May this Winter Solstice candle fill your home with life, warmth and a light that overcomes the darkness.





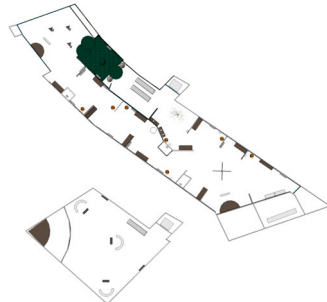

Seasonal Traditions

Visitors will have the option to purchase individual, seasonal folk rituals in the museum gift shop. These will rotate throughout the year to reflect the current season, which encourages repeat contact with the community. The aim of these seasonal rituals is to provide a personal experience that connects visitors to the pivotal role that the changing of seasons plays in Irish folk customs and beliefs. Pictured here is the Winter Solstice Candle which is available from 1 November to Jan 1.

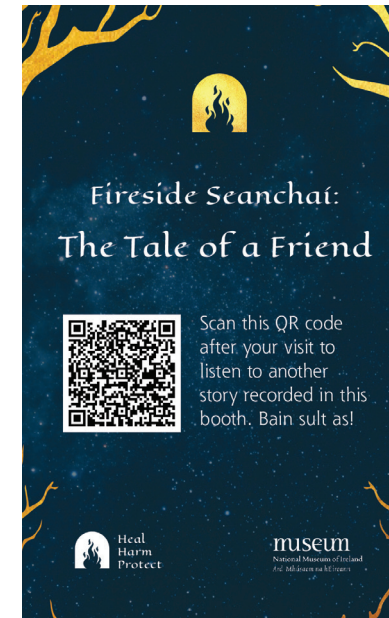
 Heal Harm Protect	
Caroline Siavichay	
PROJECT	Heal Harm Protect
CLIENT	National Museum of Ireland
DATE	12.06.23
GRAPHIC TYPE	
GRAPHIC NO.	
SCALE	
NOTES	
KEY PLAN 	
PAGE NO.	 School of Graduate Studies
49	

Post Engagement Collateral

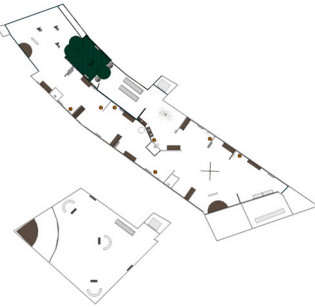

 Heal Harm Protect	
Caroline Siavichay	
PROJECT	Heal Harm Protect
CLIENT	National Museum of Ireland
DATE	12.06.23
GRAPHIC TYPE	
GRAPHIC NO.	
SCALE	
NOTES	
KEY PLAN 	
PAGE NO.	
50	 School of Graduate Studies

Fireside Seanchai

In the Marriage, Birth and Festival areas, there will be brick booths with an interactive screen inside. On the back wall, there will be a fire gobo projection giving the impression of a hearth fire. On the side wall, there will also be a content graphic giving information about the tradition of the seanchai, who are the fireside storytellers of Ireland. On the interactive touch screen, visitors will be encouraged to respond to one of the prompt questions on the screen by recording their own short story about a day in their own life related to the content area (marriage, birth or festival). This story will later be shared with another visitor. Once they finish recording, they will receive a small card with a QR code on it that will allow them to listen to a story that another visitor to the booth has recorded. This is also how their story will be shared with another visitor.

Graphic Family

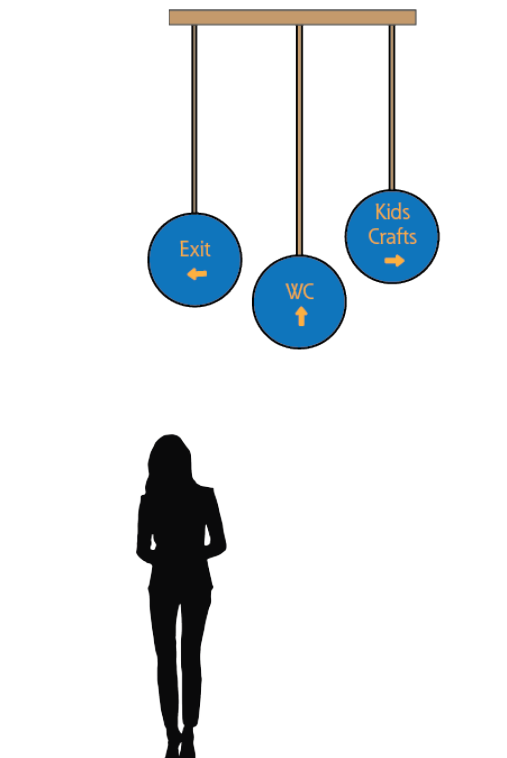
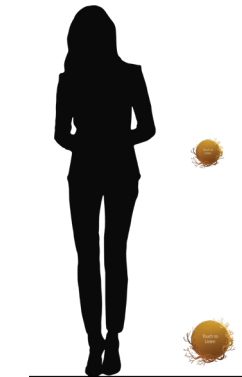

Caroline Siavichay

PROJECT Heal Harm Protect

CLIENT National Museum of Ireland

DATE 12.06.23

GRAPHIC TYPE

GRAPHIC NO.

SCALE

NOTES

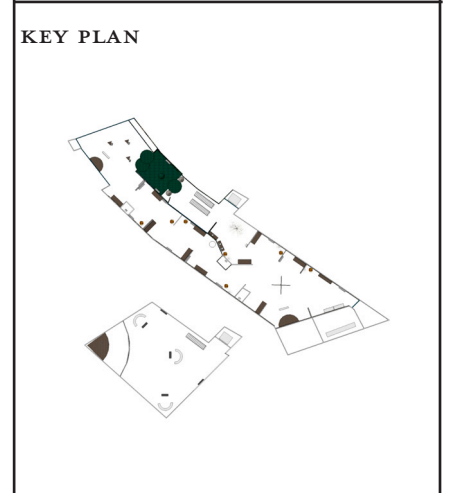

Exhibit Intro Image



Heal
Harm
Protect

Caroline Siavichay

PROJECT Heal Harm Protect

CLIENT National Museum of Ireland

DATE 12.06.23

GRAPHIC TYPE A & B

GRAPHIC NO. 01A.01.GR03-04

SCALE

NOTES

KEY PLAN

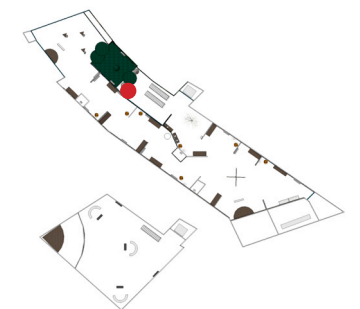

PAGE NO.

52



School of
Graduate Studies

Exhibit Intro Elevation



1 Intro Elevation
Scale: 3/8" = 1'-0"



 Heal Harm Protect	
Caroline Siavichay	
PROJECT	Heal Harm Protect
CLIENT	National Museum of Ireland
DATE	12.06.23
GRAPHIC TYPE	A & B
GRAPHIC NO.	01A.01.GR03-04
SCALE	3/8" = 1'
NOTES	
KEY PLAN	
	
PAGE NO.	 School of Graduate Studies
53	

Exhibit Intro Side & Top View

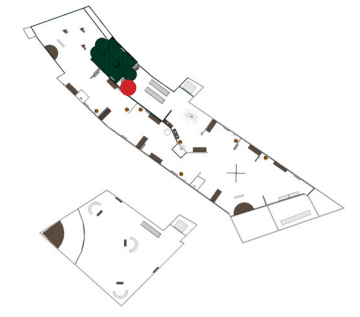

Caroline Siavichay

PROJECT	Heal Harm Protect
CLIENT	National Museum of Ireland
DATE	12.06.23
GRAPHIC TYPE	A & B
GRAPHIC NO.	01A.01.GR03-04
SCALE	3/8" = 1'

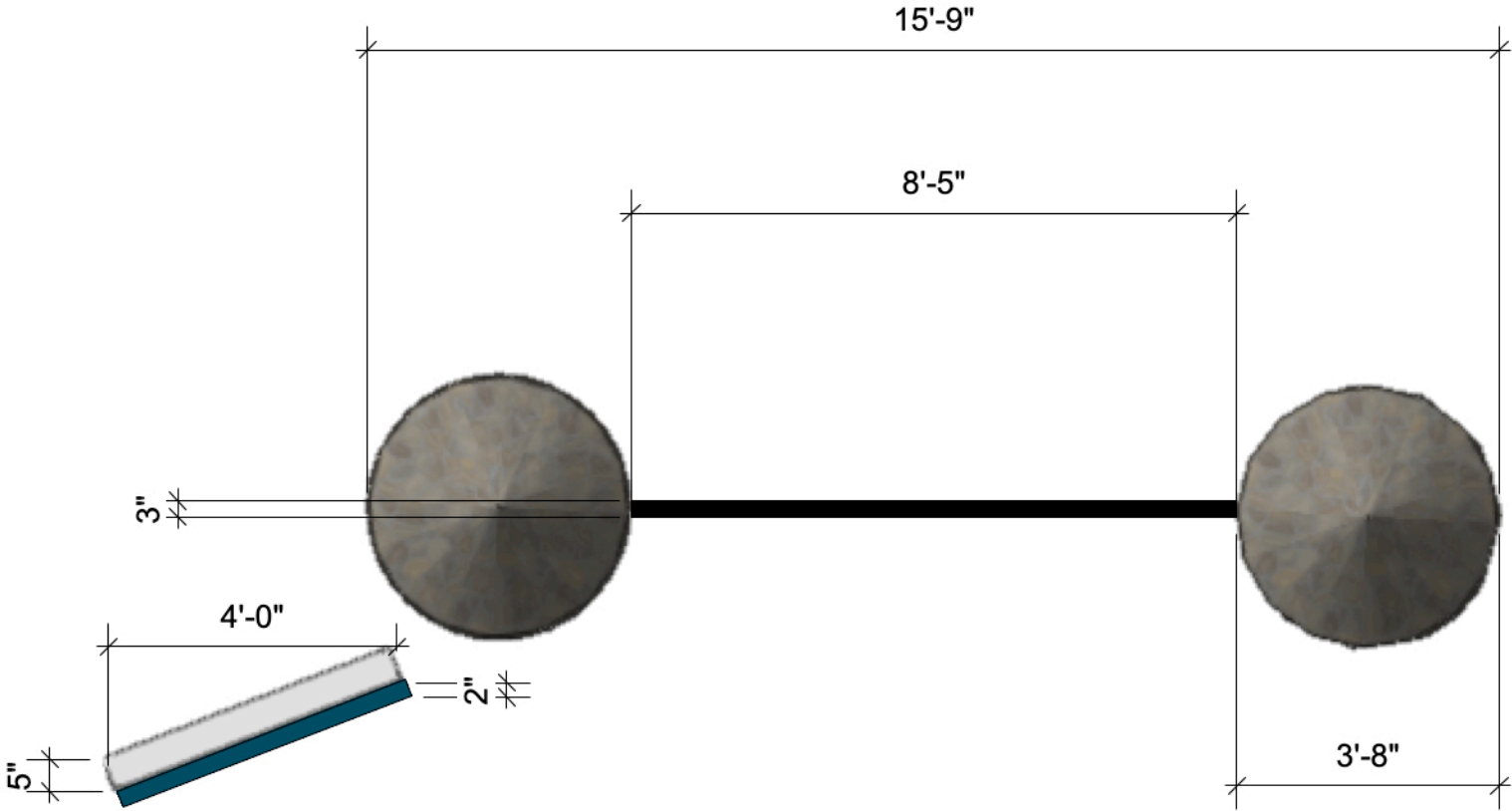
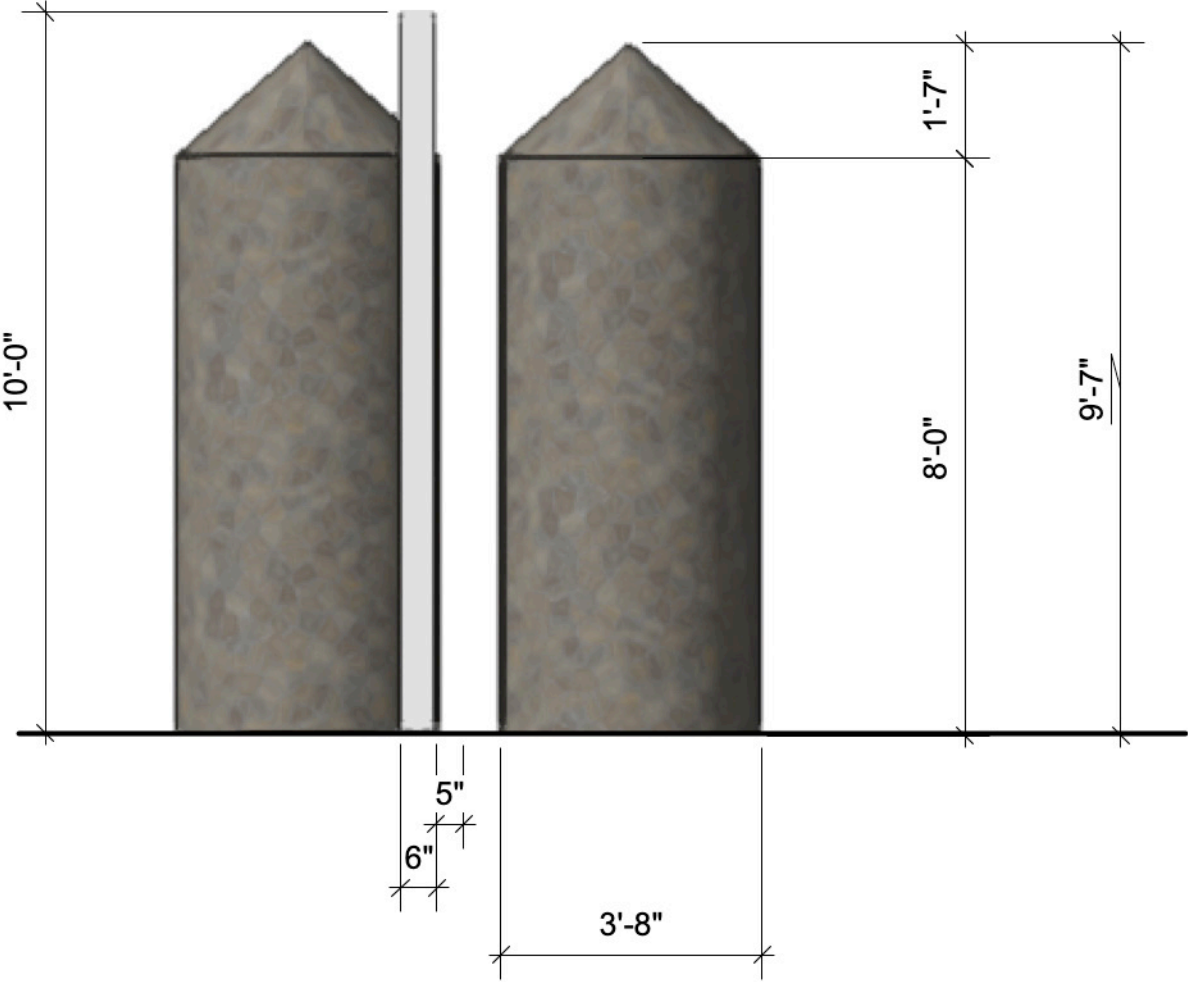
NOTES

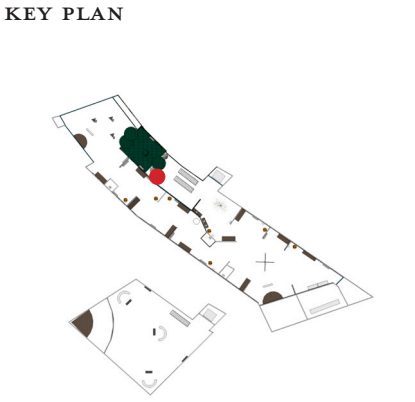

PAGE NO.



54



School of Graduate Studies

Area Intro Sign Image

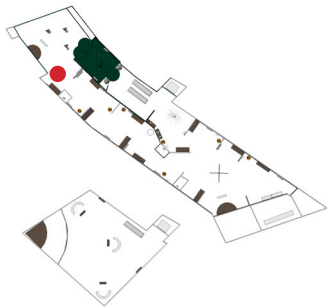

 Heal Harm Protect	
Caroline Siavichay	
PROJECT	Heal Harm Protect
CLIENT	National Museum of Ireland
DATE	12.06.23
GRAPHIC TYPE	C
GRAPHIC NO.	03A.01.GR01
SCALE	
NOTES	
KEY PLAN	
PAGE NO.	 School of Graduate Studies
55	

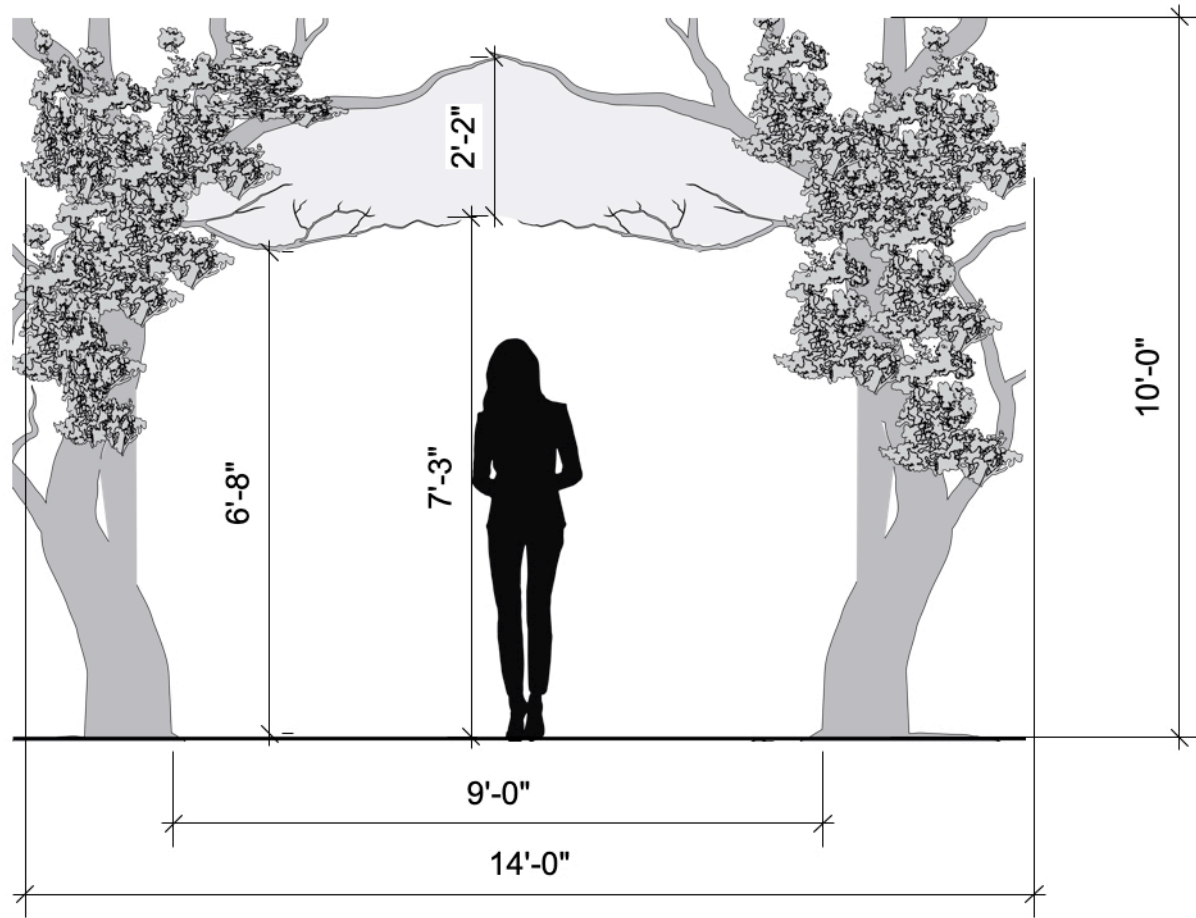

Area Intro Sign

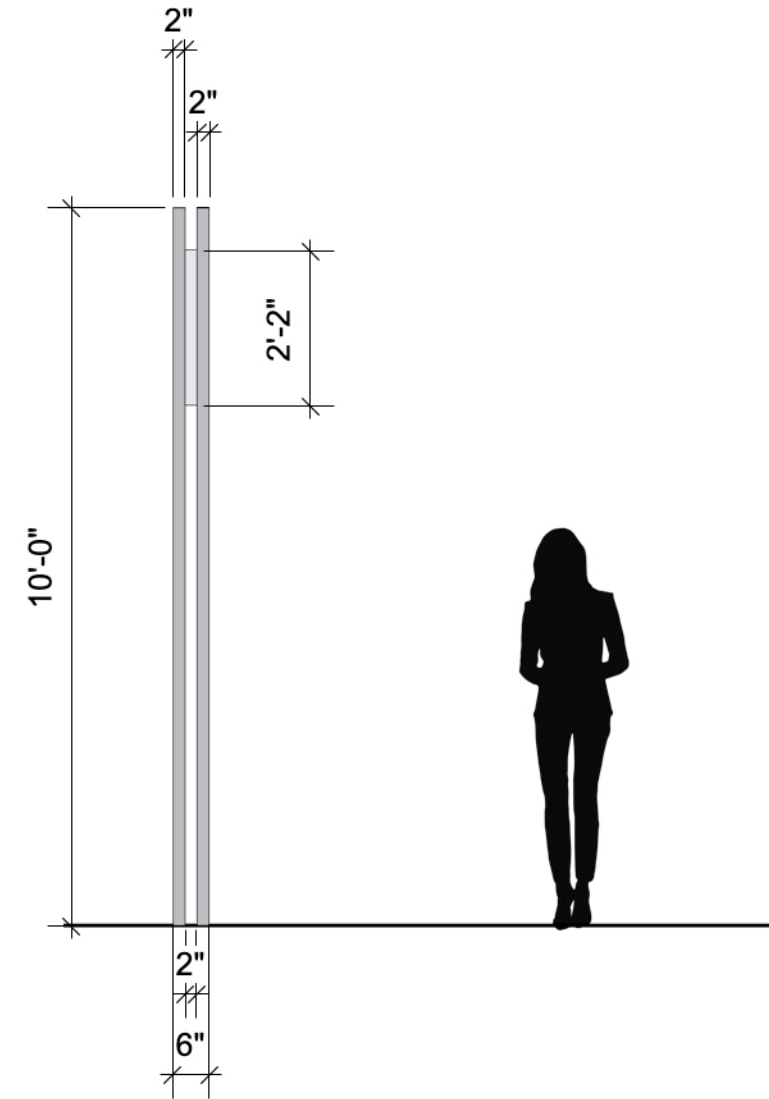

1 **Area Intro Elevation**
Scale: 3/8" = 1'-0"



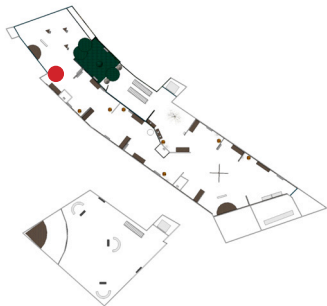

2 **Area Intro Side Elevation**
Scale: 3/8" = 1'-0"

 Heal Harm Protect	
Caroline Siavichay	
PROJECT	Heal Harm Protect
CLIENT	National Museum of Ireland
DATE	12.06.23
GRAPHIC TYPE	C
GRAPHIC NO.	03A.01.GR01
SCALE	3/8" = 1'
NOTES	
KEY PLAN	
	
PAGE NO.	 School of Graduate Studies
56	

Content Graphics

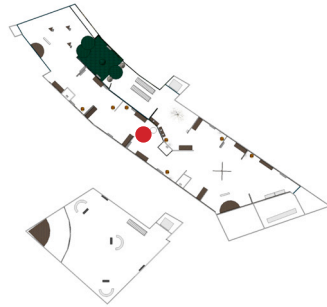

 Heal Harm Protect	
Caroline Siavichay	
PROJECT	Heal Harm Protect
CLIENT	National Museum of Ireland
DATE	12.06.23
GRAPHIC TYPE	D
GRAPHIC NO.	04A.01.GR03-04
SCALE	
NOTES	
KEY PLAN	
PAGE NO.	 School of Graduate Studies
57	

Caroline Siavichay

PROJECT Heal Harm Protect

CLIENT National Museum of Ireland

DATE 12.06.23

GRAPHIC TYPE D

GRAPHIC NO. 04A.01.GR03-04

SCALE 3/8" = 1'

NOTES

KEY PLAN

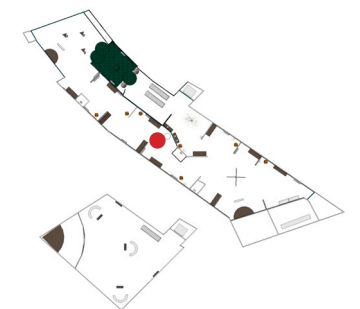

PAGE NO.

58

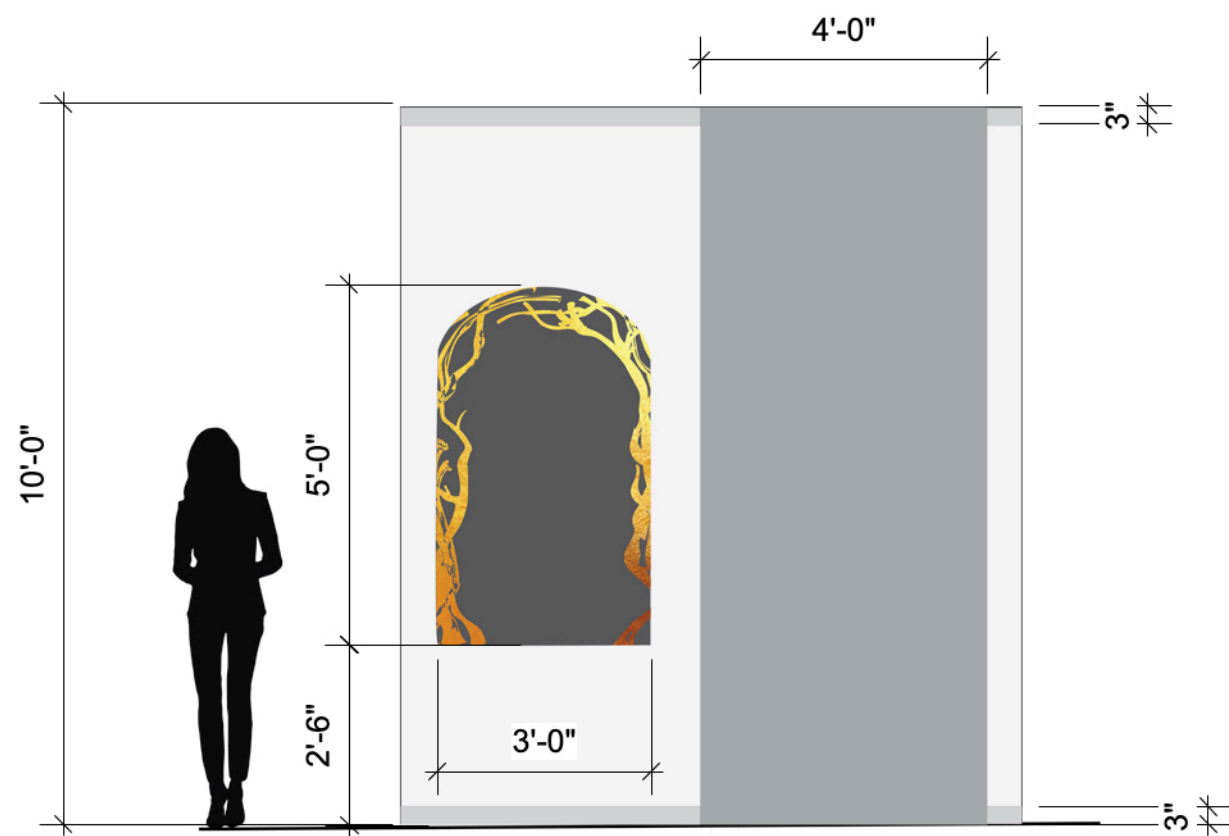

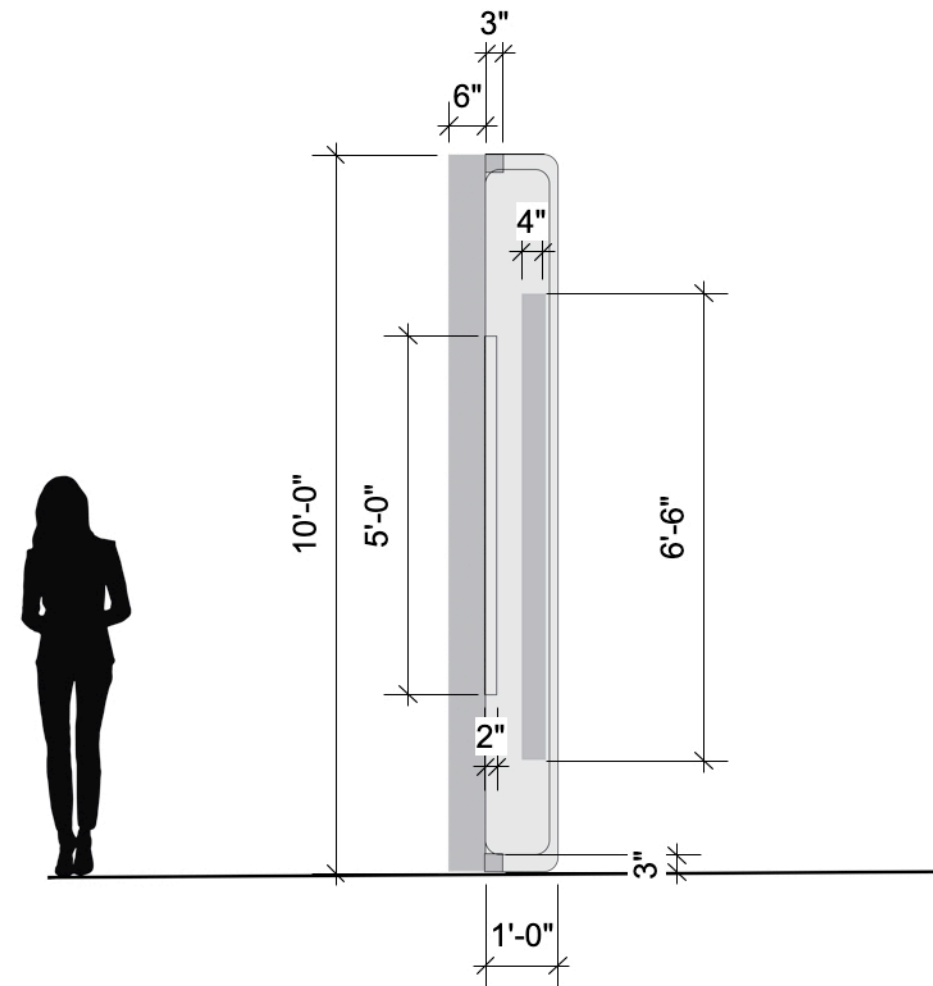

1 **Content Wall Elevation**
Scale: 3/8" = 1'-0"



2 **Content Wall Side Elevation**
Scale: 3/8" = 1'-0"

Label Rail Image

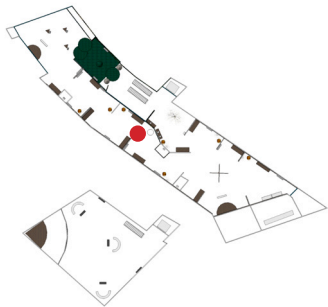

 Heal Harm Protect	
Caroline Siavichay	
PROJECT	Heal Harm Protect
CLIENT	National Museum of Ireland
DATE	12.06.23
GRAPHIC TYPE	D
GRAPHIC NO.	04A.01.GR08
SCALE	
NOTES	
<p>KEY PLAN</p> 	
PAGE NO.	
59	 School of Graduate Studies

Label Rail Elevation and Side View

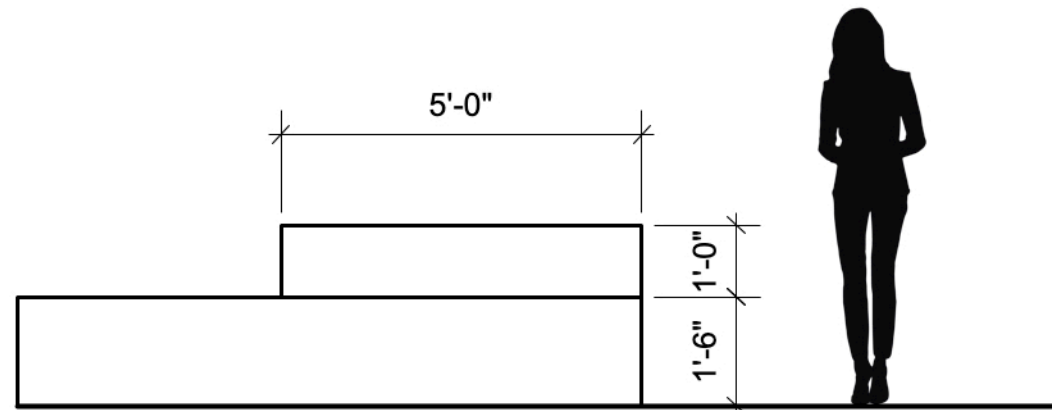

1 **Label Rail Elevation**
Scale: 3/8" = 1'-0"

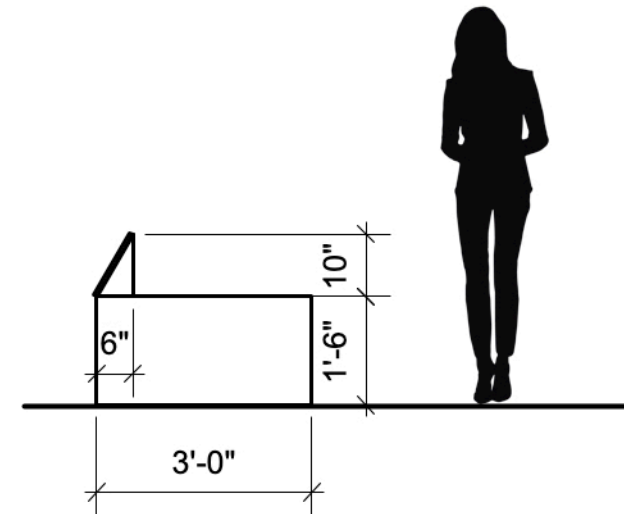

2 **Label Rail Side Elevation**
Scale: 3/8" = 1'-0"



Caroline Siavichay

PROJECT Heal Harm Protect

CLIENT National Museum of Ireland

DATE 12.06.23

GRAPHIC TYPE D

GRAPHIC NO. 04A.01.GR08

SCALE 3/8" = 1'

NOTES

KEY PLAN

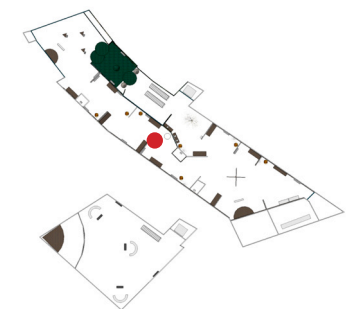

PAGE NO.

60



School of Graduate Studies

Directive Image and Elevation

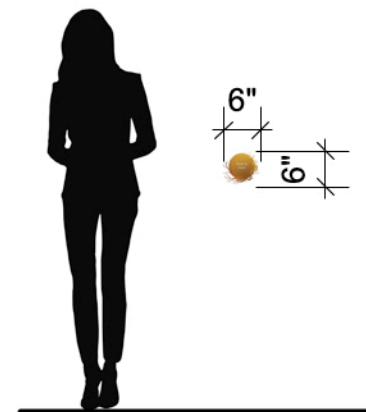

1 Directive Elevation
Scale: 3/8" = 1'-0"



Caroline Siavichay

PROJECT Heal Harm Protect

CLIENT National Museum of Ireland

DATE 12.06.23

GRAPHIC TYPE E

GRAPHIC NO. 03A.01.GR16

SCALE 3/8" = 1'

NOTES

KEY PLAN

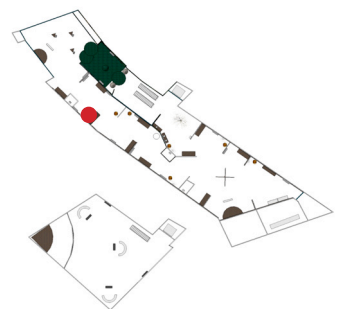



PAGE NO.

61



Exterior Wayfinding Image

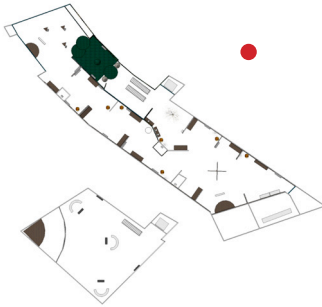

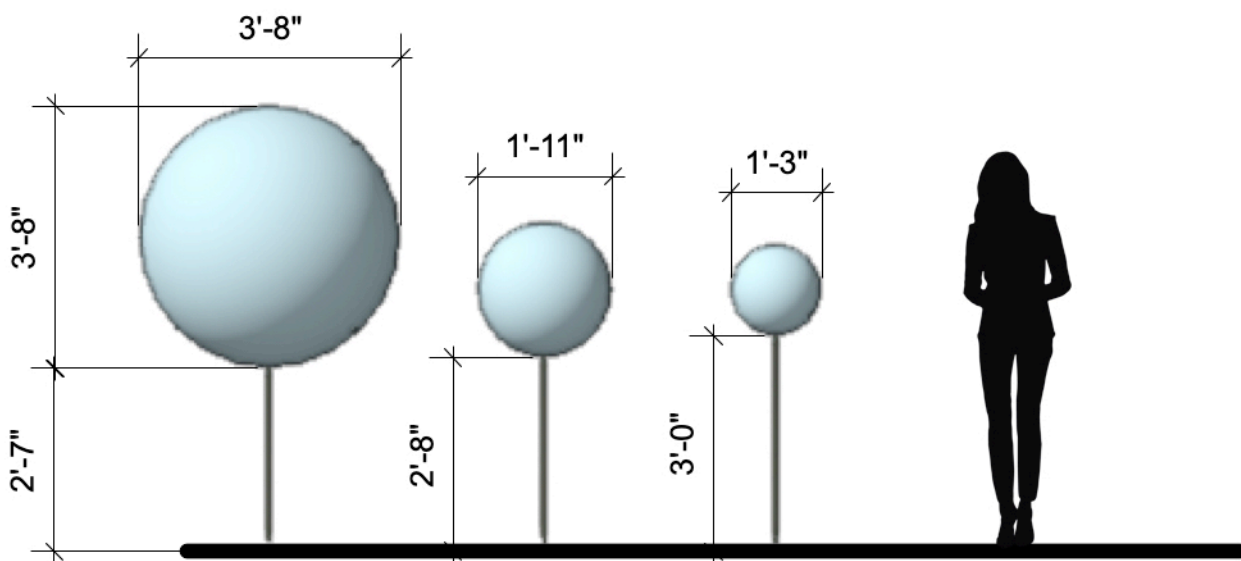

 Heal Harm Protect	
Caroline Siavichay	
PROJECT	Heal Harm Protect
CLIENT	National Museum of Ireland
DATE	12.06.23
GRAPHIC TYPE	G
GRAPHIC NO.	08A.01.GR01
SCALE	
NOTES	
KEY PLAN	
	
PAGE NO.	 School of Graduate Studies
62	

Exterior Wayfinding Elevation



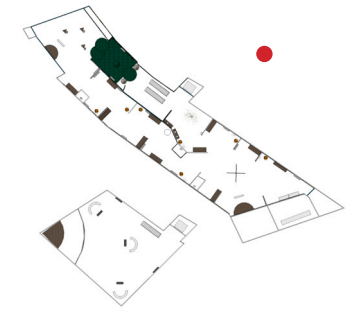

1 Outdoor Wayfinding Elevation
Scale: 3/8" = 1'-0"

 Heal Harm Protect	
Caroline Siavichay	
PROJECT	Heal Harm Protect
CLIENT	National Museum of Ireland
DATE	12.06.23
GRAPHIC TYPE	G
GRAPHIC NO.	08A.01.GR01
SCALE	3/8" = 1'
NOTES	
KEY PLAN	
	
PAGE NO.	 School of Graduate Studies
63	

Interior Wayfinding Image

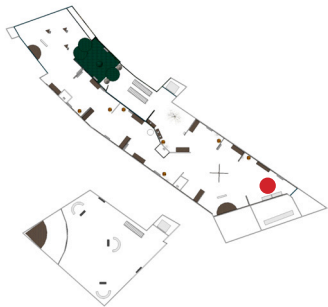

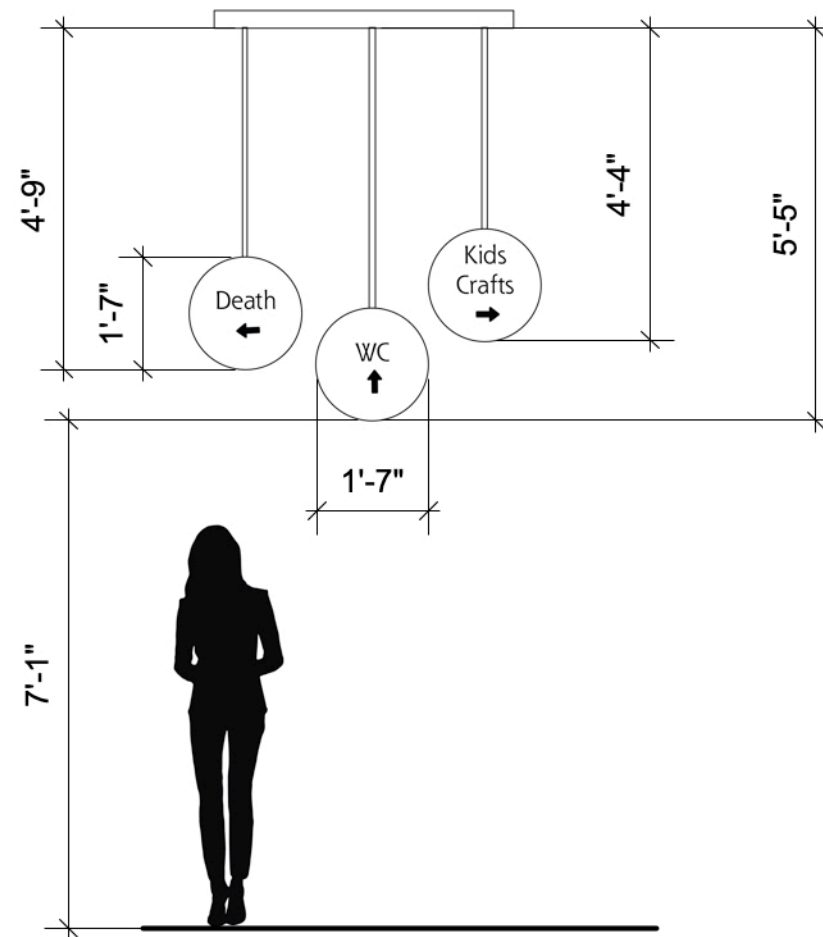

 Heal Harm Protect	
Caroline Siavichay	
PROJECT	Heal Harm Protect
CLIENT	National Museum of Ireland
DATE	12.06.23
GRAPHIC TYPE	G
GRAPHIC NO.	05A.01.GR14
SCALE	
NOTES	
KEY PLAN 	
PAGE NO.	
64	 School of Graduate Studies

Interior Wayfinding Elevation

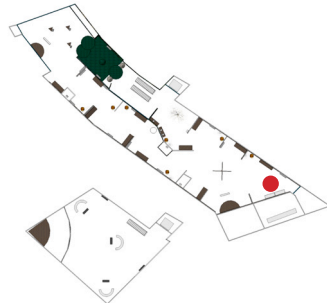

1 **Indoor Wayfinding Elevation**
Scale: 3/8" = 1'-0"

 Heal Harm Protect	
Caroline Siavichay	
PROJECT	Heal Harm Protect
CLIENT	National Museum of Ireland
DATE	12.06.23
GRAPHIC TYPE	G
GRAPHIC NO.	05A.01.GR14
SCALE	3/8" = 1'
NOTES	
<p>KEY PLAN</p> 	
PAGE NO.	 School of Graduate Studies
65	





Exhibition Detailing

Area 1: Marriage



Something Old, Something New

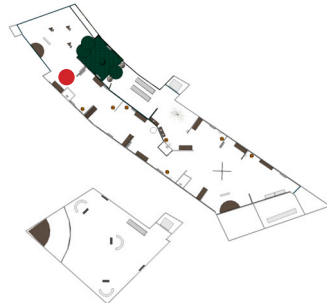

Marriage is the first space that is meant to feel as though it is the interior of a home, as each home interior area is based around a special day in the home. After entering through a golden archway of trees, visitors will see limestone-washed walls. Hanging from the ceiling will be golden branch chandeliers, meant to symbolize the peat and rush torches traditionally used to light homes. They will also see large stone panels with main quotes/pull out facts cut into the stone. These quotes/facts will be backlit in a way that makes them seem to flicker like a fire in a stone hearth. There will also be content info graphic panels shaped like rounded windows on the walls. These give in depth information about the customs and beliefs related to the artifacts on display. There will also be display cases with artifacts related to weddings and marriage. On the back wall inside the display case, there will be projected silhouettes interacting with the artifacts. Visitors will also be able to view special related items collected from the local community and hear first hand accounts about them. They will also be able to record their own stories in the Fireside Seanchai booths. The overall atmosphere is cozy and communal with a vein of magical mystery running through it.

 Heal Harm Protect	
Caroline Siavichay	
PROJECT	Heal Harm Protect
CLIENT	National Museum of Ireland
DATE	12.06.23
GRAPHIC TYPE	
GRAPHIC NO.	
SCALE	
NOTES	
KEY PLAN 	
PAGE NO.	
67	 School of Graduate Studies

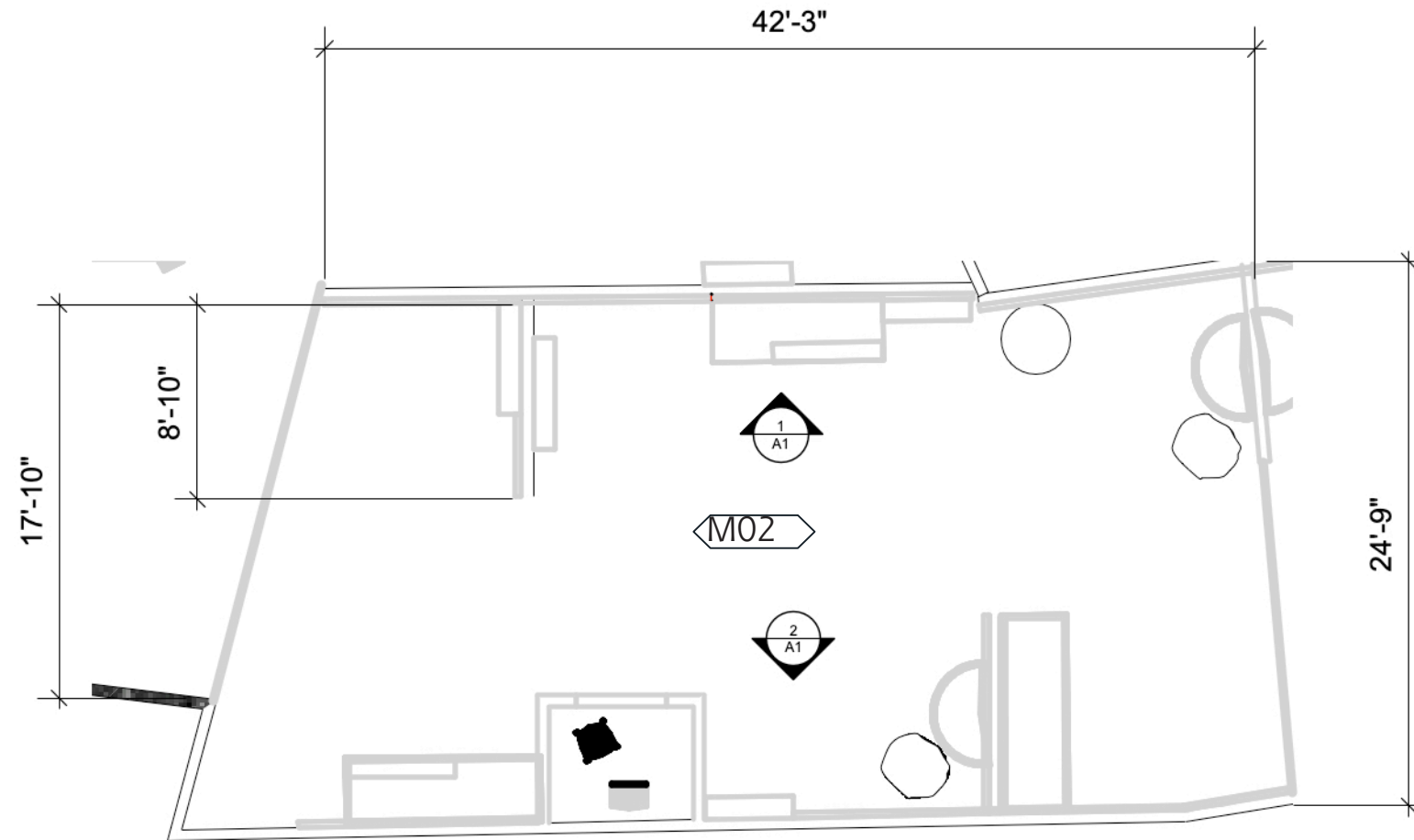
Area Detail Plan



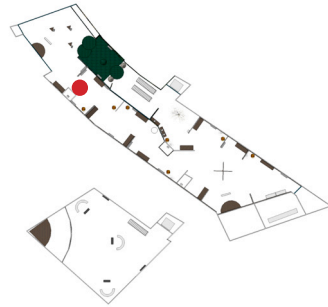

1 Marriage Area Detail Plan
Scale: 1/8" = 1'-0"

 Heal Harm Protect	
Caroline Siavichay	
PROJECT	Heal Harm Protect
CLIENT	National Museum of Ireland
DATE	12.06.23
GRAPHIC TYPE	
GRAPHIC NO.	
SCALE	
NOTES	
KEY PLAN	
PAGE NO.	 School of Graduate Studies
68	

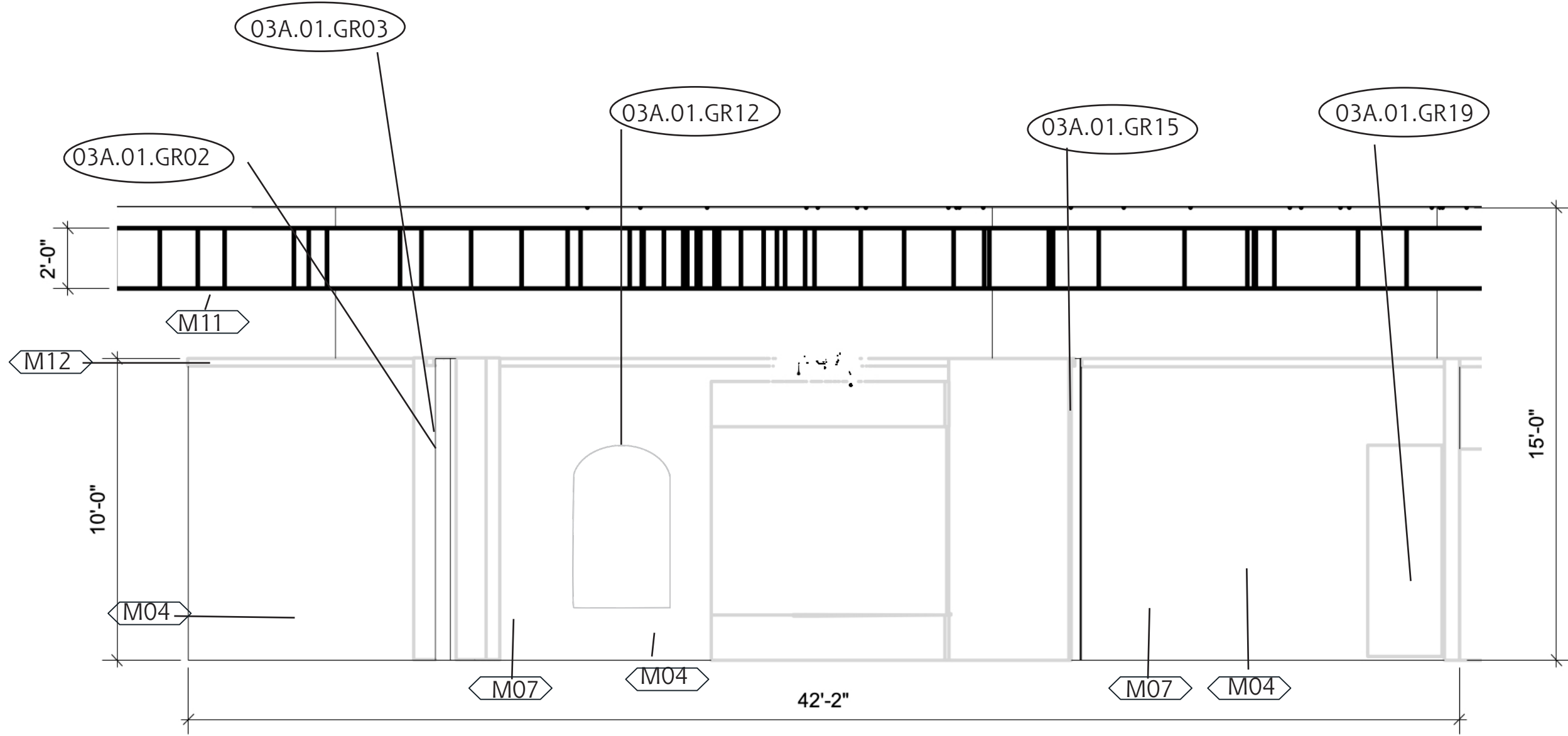
Elevations and Details



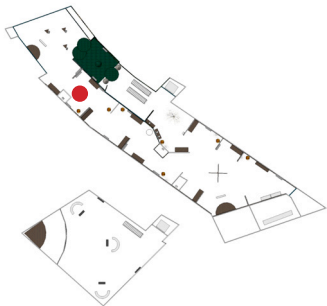

1 **Marriage Left Elevation**
Scale: 1/4" = 1'-0"

 Heal Harm Protect	
Caroline Siavichay	
PROJECT	Heal Harm Protect
CLIENT	National Museum of Ireland
DATE	12.06.23
GRAPHIC TYPE	
GRAPHIC NO.	
SCALE	
NOTES	
KEY PLAN 	
PAGE NO.	
69	 School of Graduate Studies

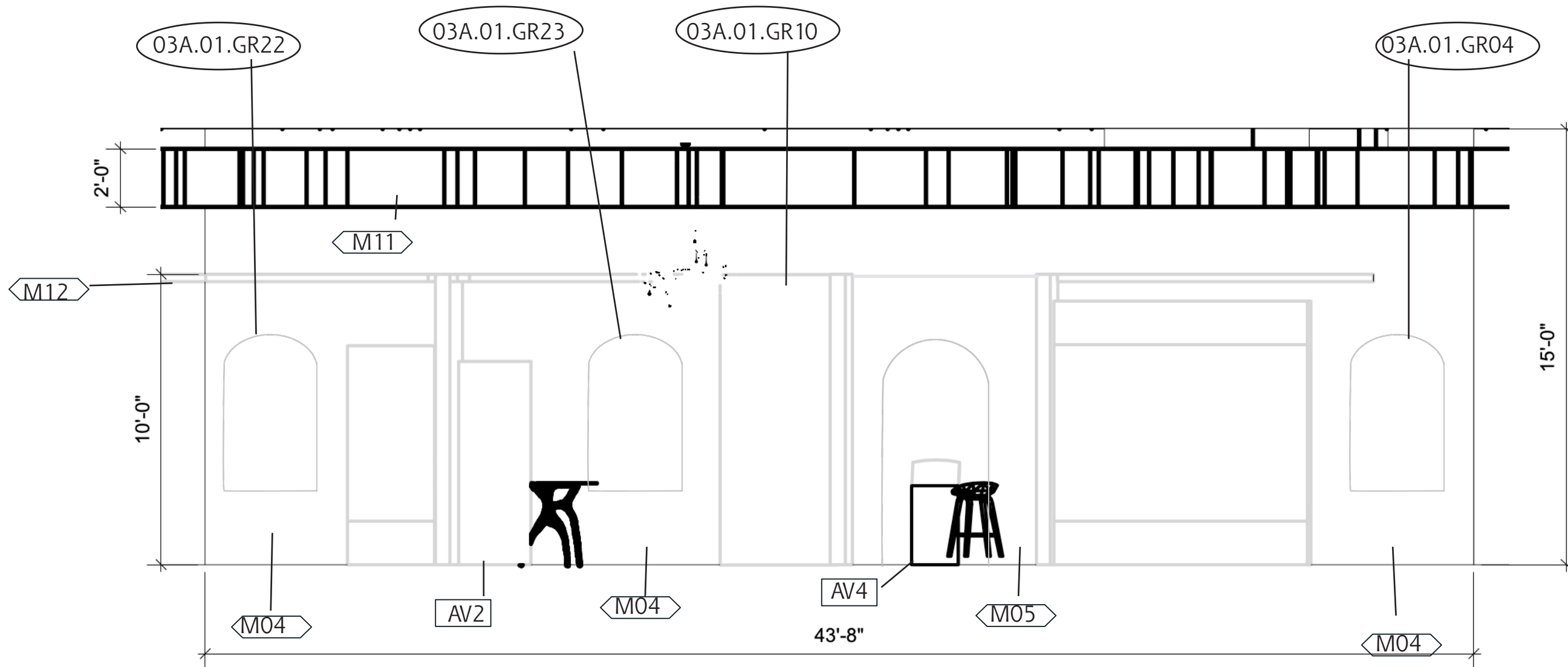
Elevations and Details

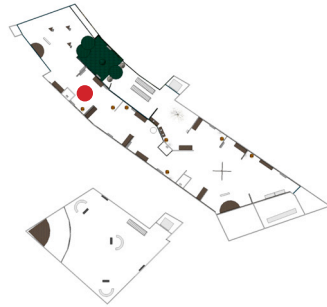

2 **Marriage Right Elevation**
Scale: 1/4" = 1'-0"

 Heal Harm Protect	
Caroline Siavichay	
PROJECT	Heal Harm Protect
CLIENT	National Museum of Ireland
DATE	12.06.23
GRAPHIC TYPE	
GRAPHIC NO.	
SCALE	
NOTES	
<p>KEY PLAN</p> 	
PAGE NO.	
70	 School of Graduate Studies

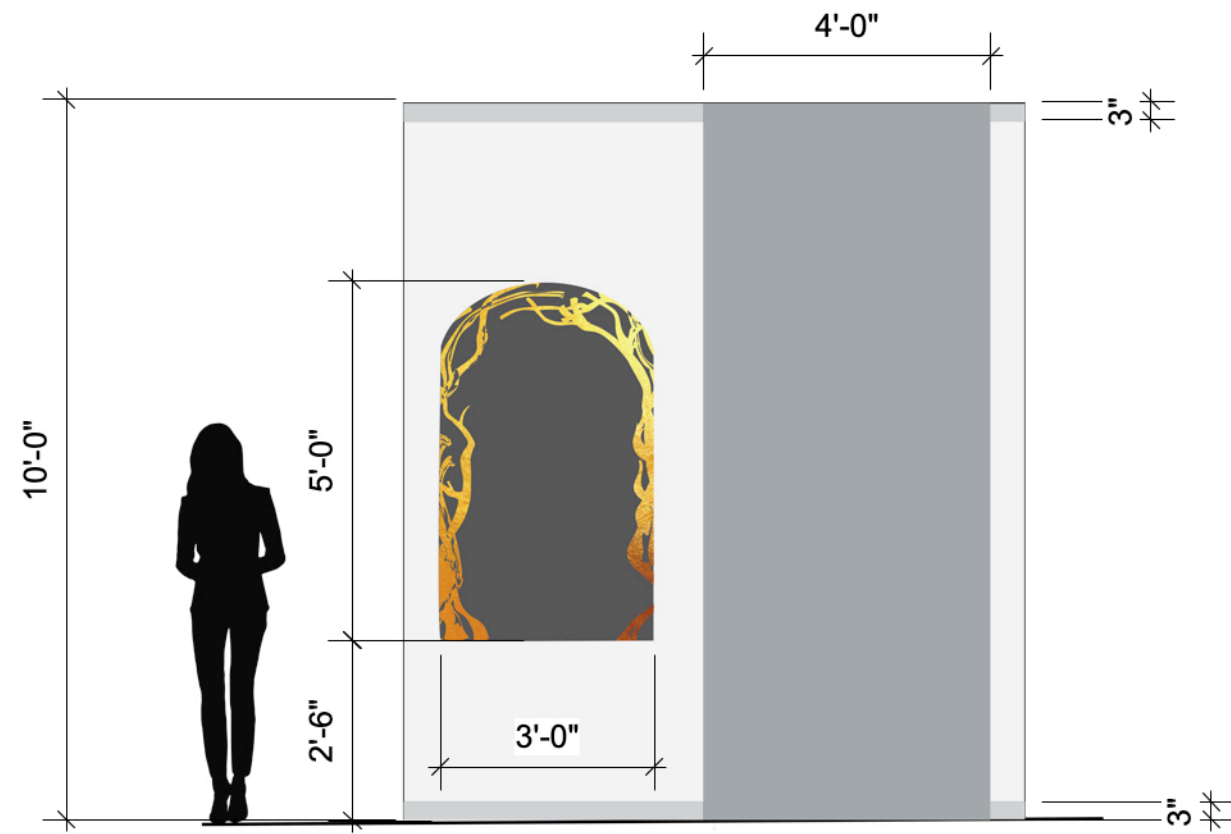

Content Graphics Detailing

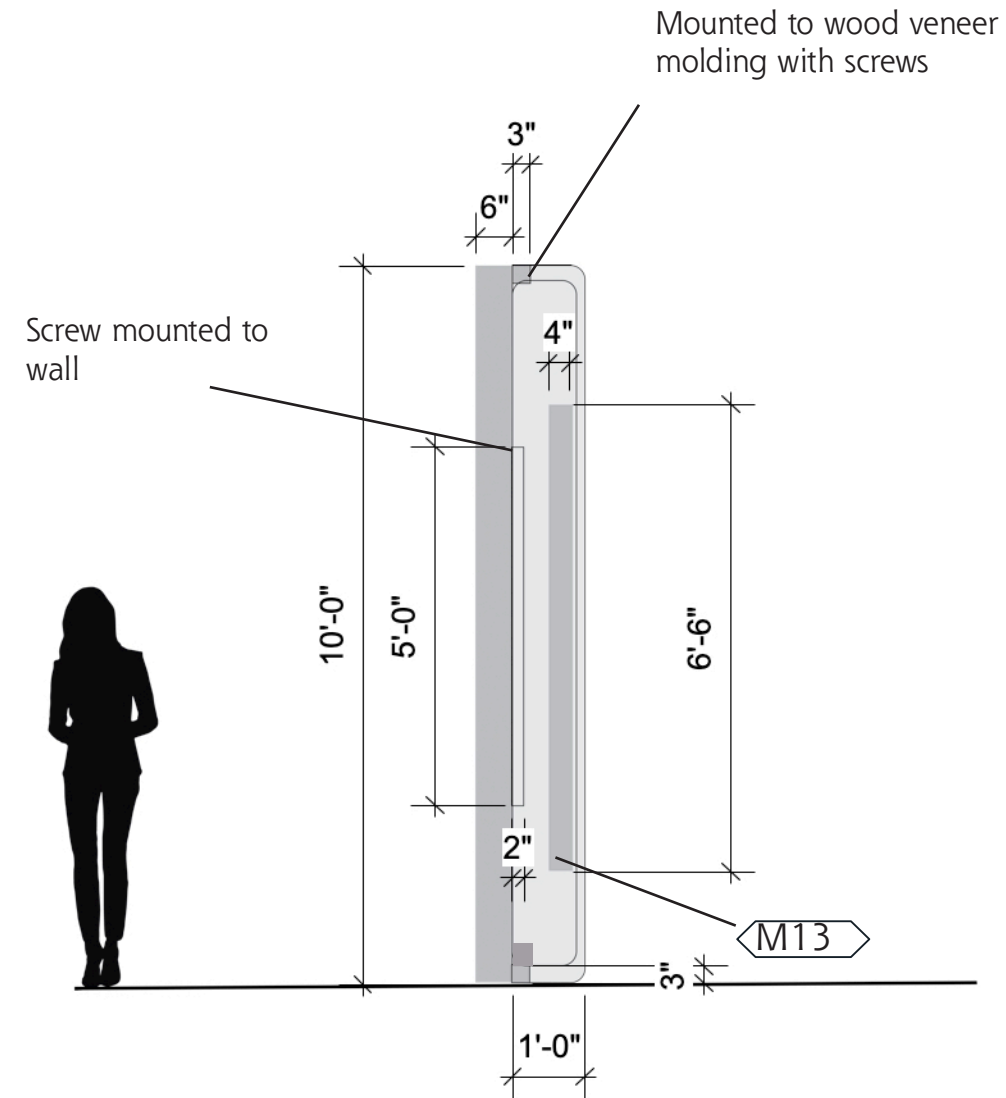

1 **Content Wall Elevation**
Scale: 3/8" = 1'-0"

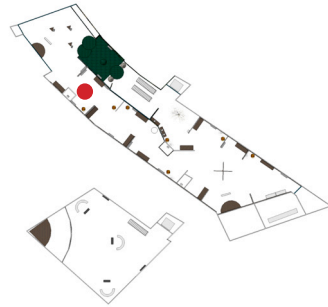

2 **Content Wall Side Elevation**
Scale: 3/8" = 1'-0"

 Heal Harm Protect	
Caroline Siavichay	
PROJECT	Heal Harm Protect
CLIENT	National Museum of Ireland
DATE	12.06.23
GRAPHIC TYPE	
GRAPHIC NO.	
SCALE	
NOTES	
<p>KEY PLAN</p> 	
PAGE NO.	 School of Graduate Studies
71	

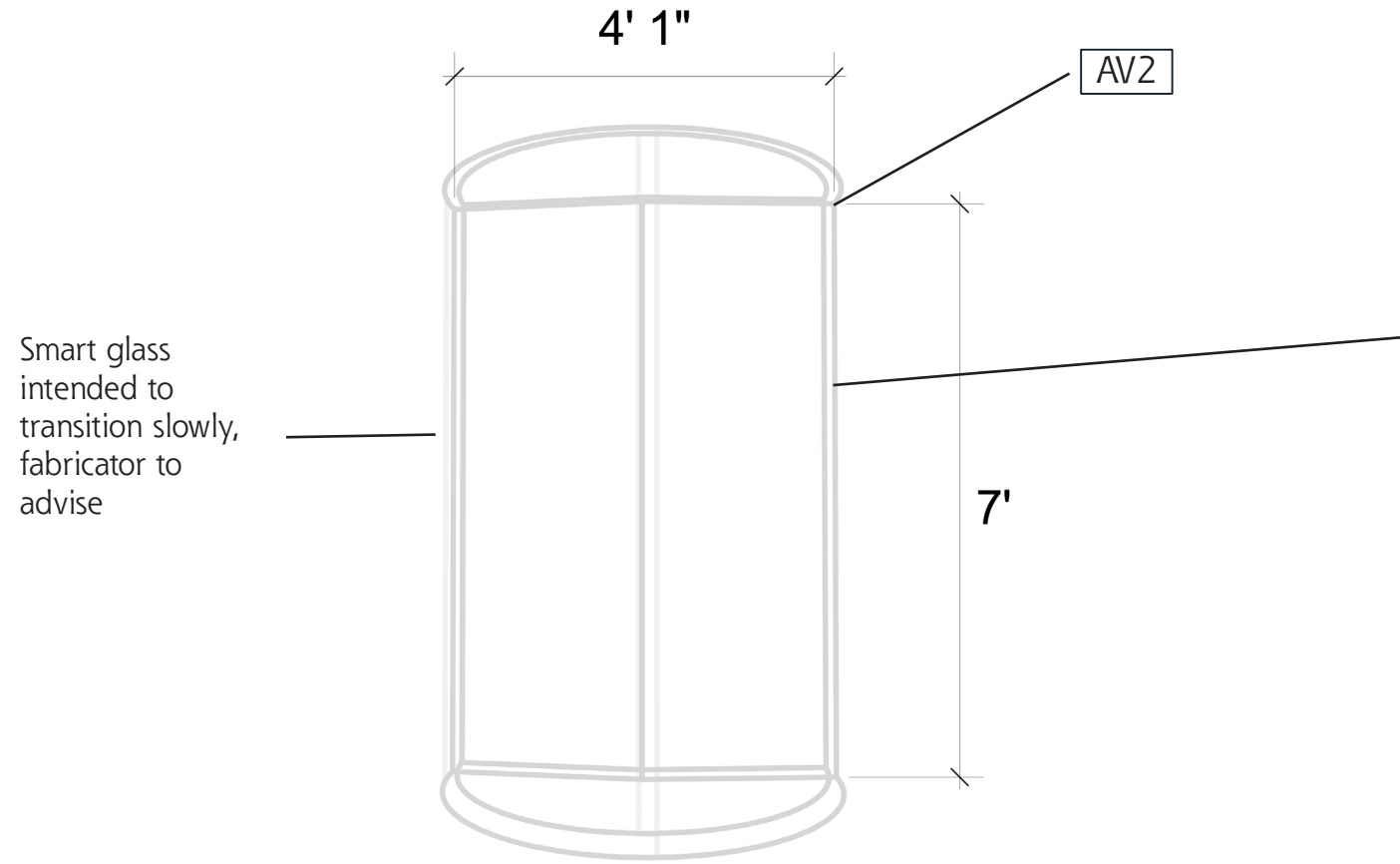

Community Object Case Detailing

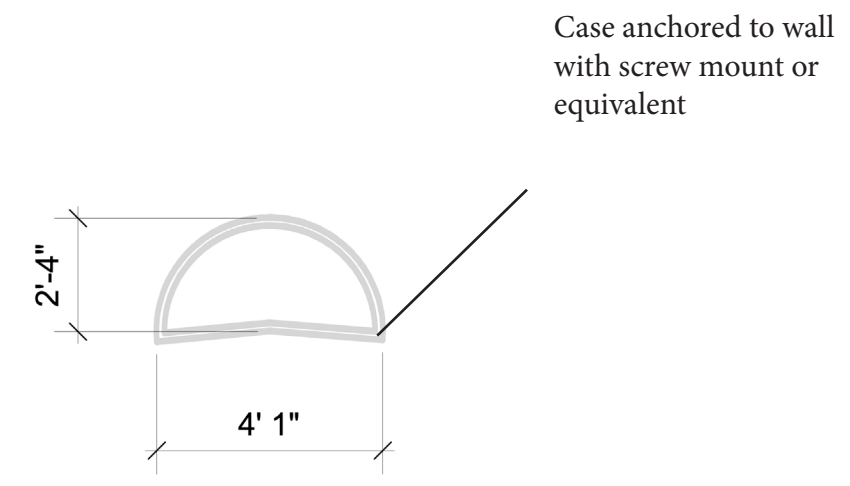

1 **Community Object Case Elevation**
Scale: 1/8" = 1'-0"

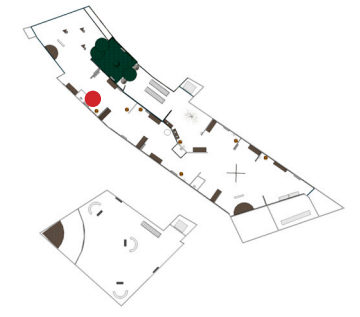

2 **Community Object Case Plan**
Scale: 1/4" = 1'-0"

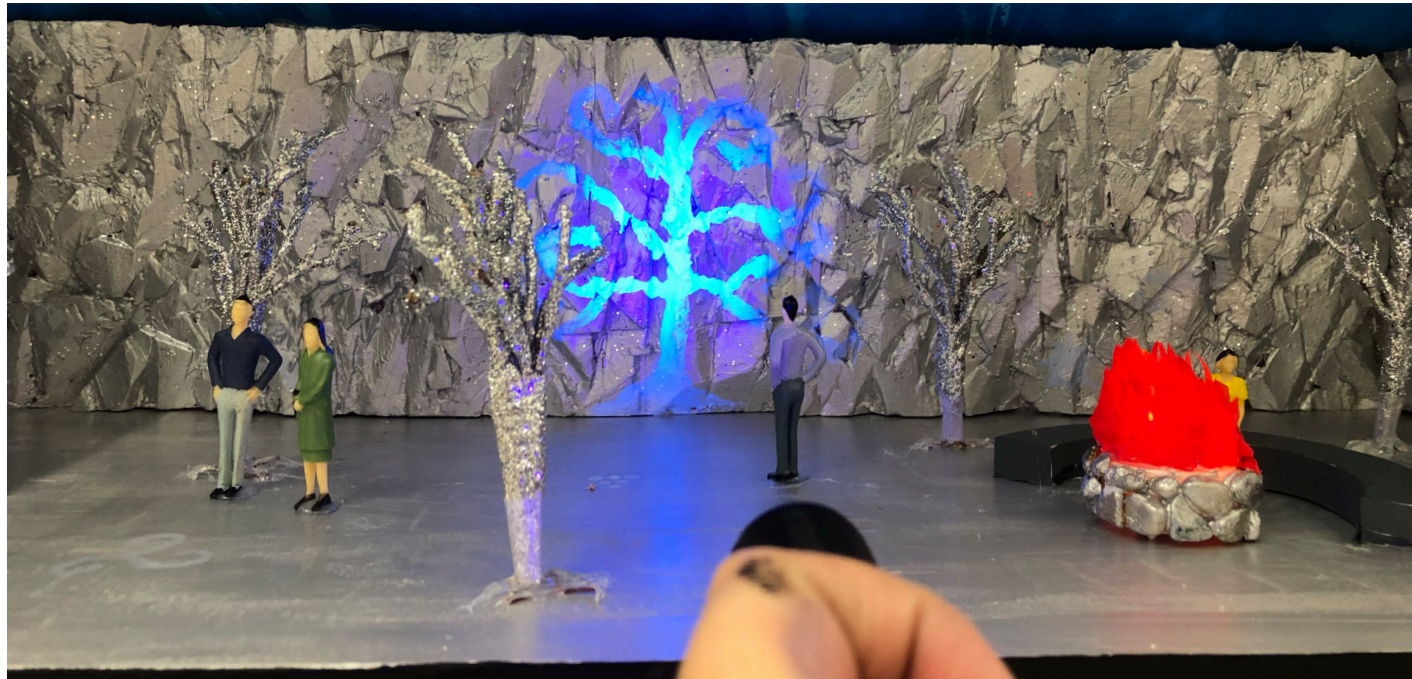
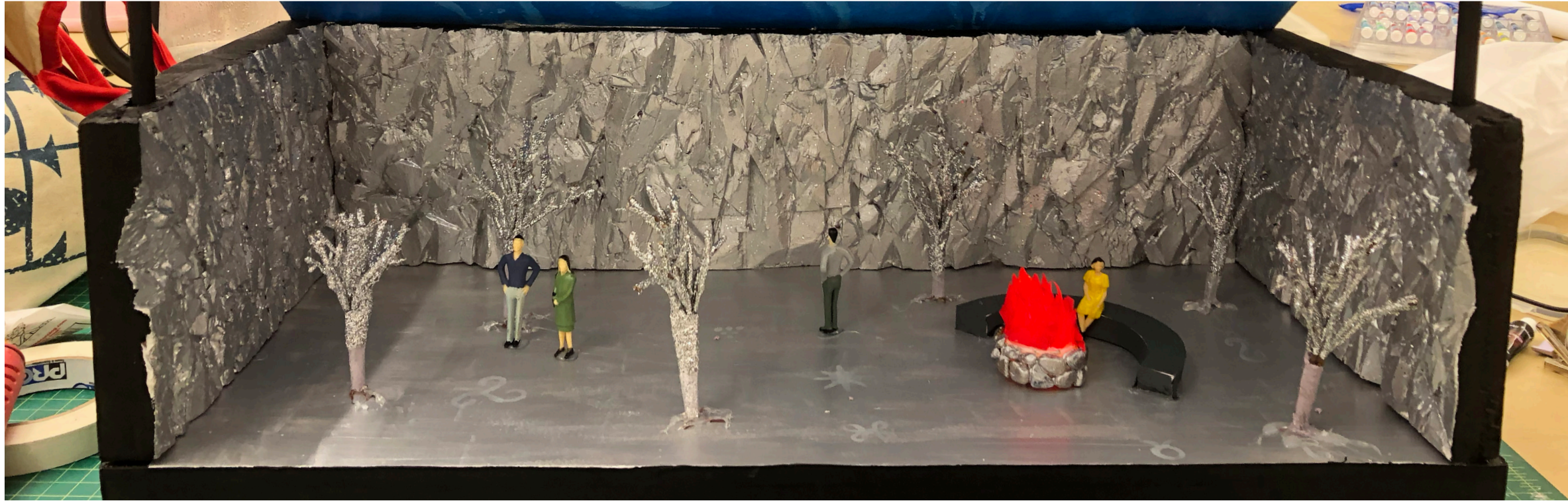

 Heal Harm Protect	
Caroline Siavichay	
PROJECT	Heal Harm Protect
CLIENT	National Museum of Ireland
DATE	12.06.23
GRAPHIC TYPE	
GRAPHIC NO.	
SCALE	
NOTES	
KEY PLAN	
	
PAGE NO.	 School of Graduate Studies
72	

Area 2: The Otherworld



Beyond the Veil

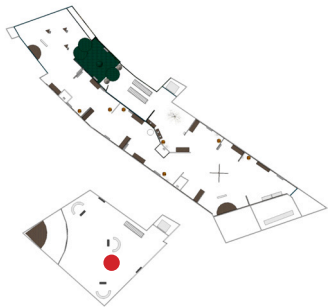

The Otherworld is situated on a lower level than the rest of the exhibition. Upon entry visitors will see silver glittering rock walls and trees and a silver glittering carpet, as well as content information graphics that teach them about the storied history of the Otherworld and the practice of divination used to decipher messages from the fairies and ghosts who reside there. There will also be bins with small UV flashlights and directive graphics instructing visitors to take one. Attached to the end of each flashlight is a card that shows multiple Irish symbols that are hidden in UV paint around the area. Visitors are instructed to use their UV flashlights to find the hidden symbols, then use their cards to “decipher the messages” left for them through the hidden symbols. There is also a walled off performance area where visitors will experience one last traditional Irish folktale performance with interactive projection mapping. This is the most experiential space of the exhibition and has an atmosphere of otherworldly fantasy.

 Heal Harm Protect	
Caroline Siavichay	
PROJECT	Heal Harm Protect
CLIENT	National Museum of Ireland
DATE	12.06.23
GRAPHIC TYPE	
GRAPHIC NO.	
SCALE	
NOTES	
KEY PLAN 	
PAGE NO.	
73	 School of Graduate Studies

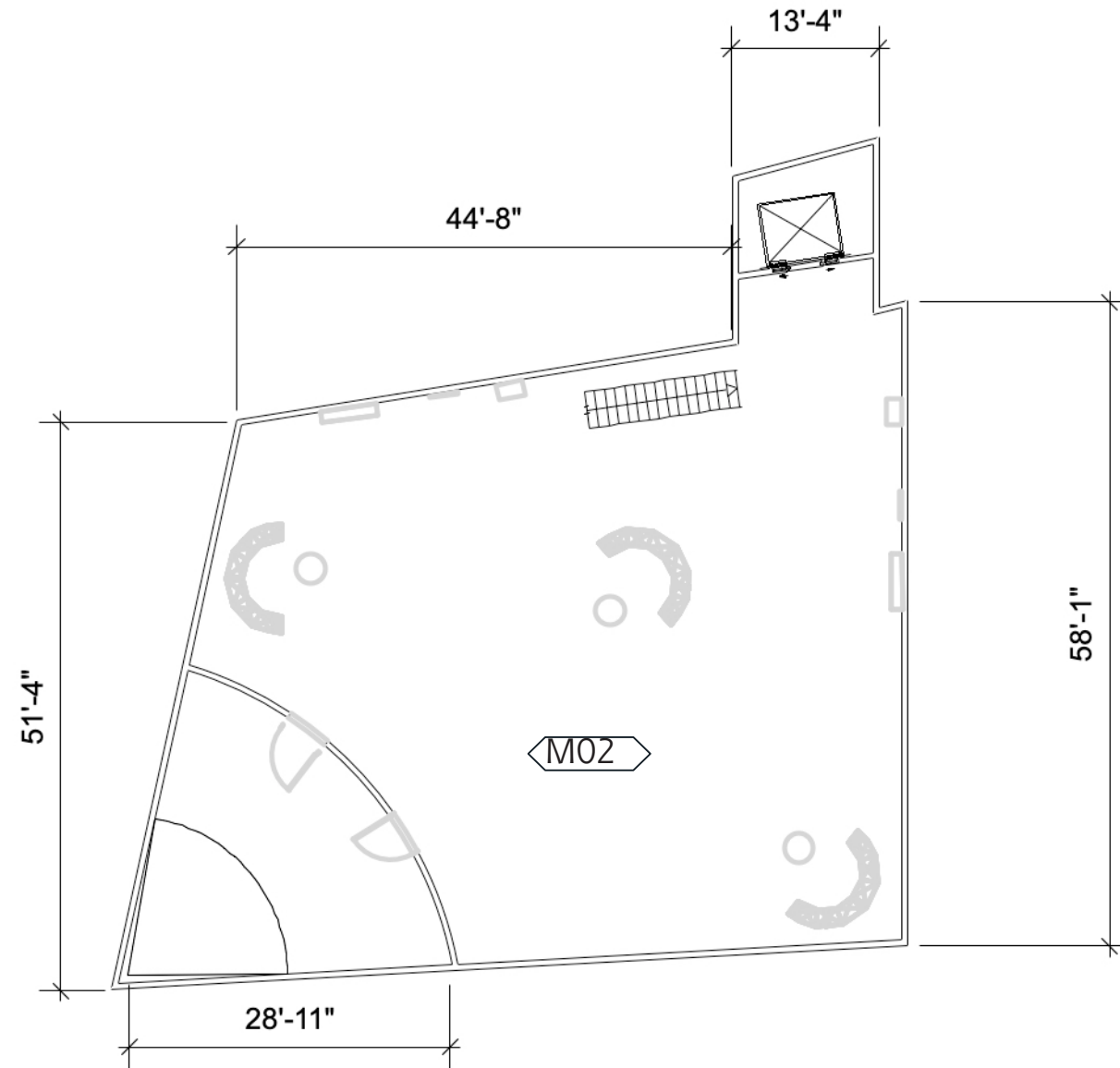
Area Detail Plan



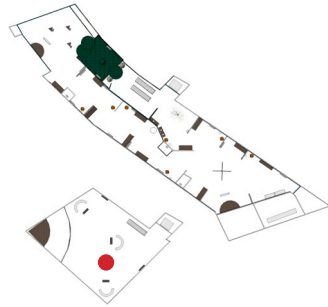

1 **Otherworld Detail Plan**
Scale: 1/16" = 1'-0"

 Heal Harm Protect	
Caroline Siavichay	
PROJECT	Heal Harm Protect
CLIENT	National Museum of Ireland
DATE	12.06.23
GRAPHIC TYPE	
GRAPHIC NO.	
SCALE	
NOTES	
KEY PLAN	
PAGE NO.	
74	 School of Graduate Studies

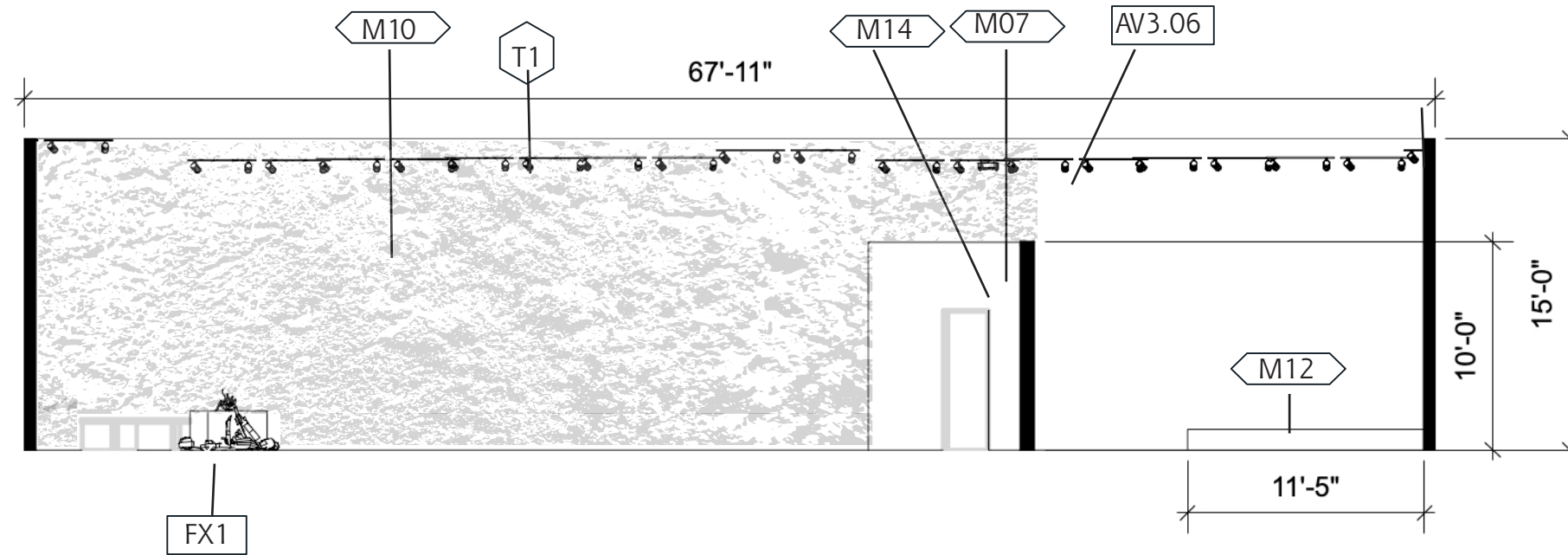
Elevations and Details

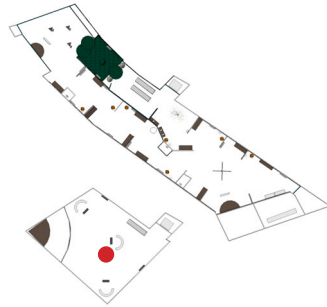

1 **Otherworld Section**
Scale: 1/8" = 1'-0"

 Heal Harm Protect	
Caroline Siavichay	
PROJECT	Heal Harm Protect
CLIENT	National Museum of Ireland
DATE	12.06.23
GRAPHIC TYPE	
GRAPHIC NO.	
SCALE	
NOTES	
<p>KEY PLAN</p> 	
PAGE NO.	
75	 School of Graduate Studies

Technifex Fire Detailing

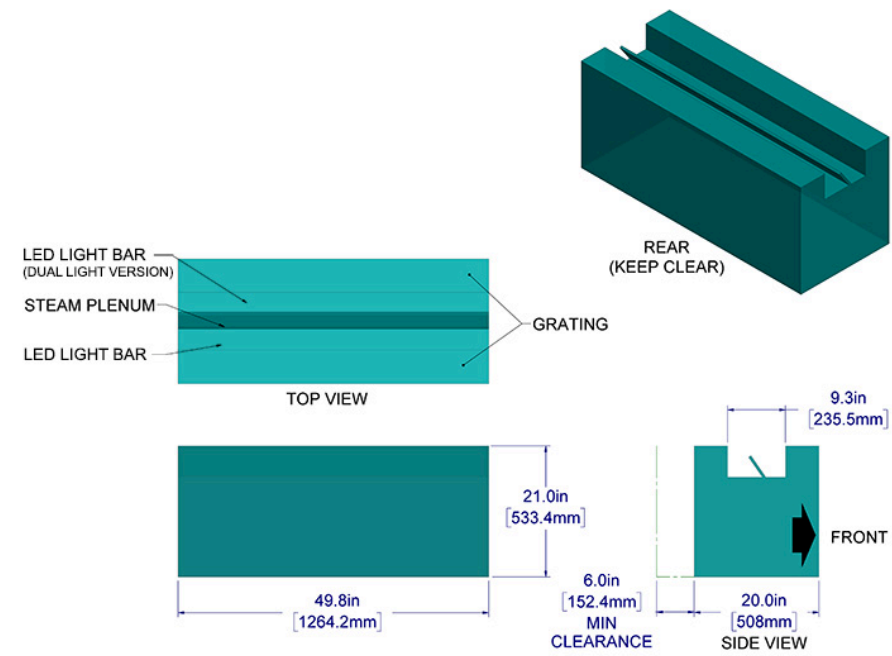
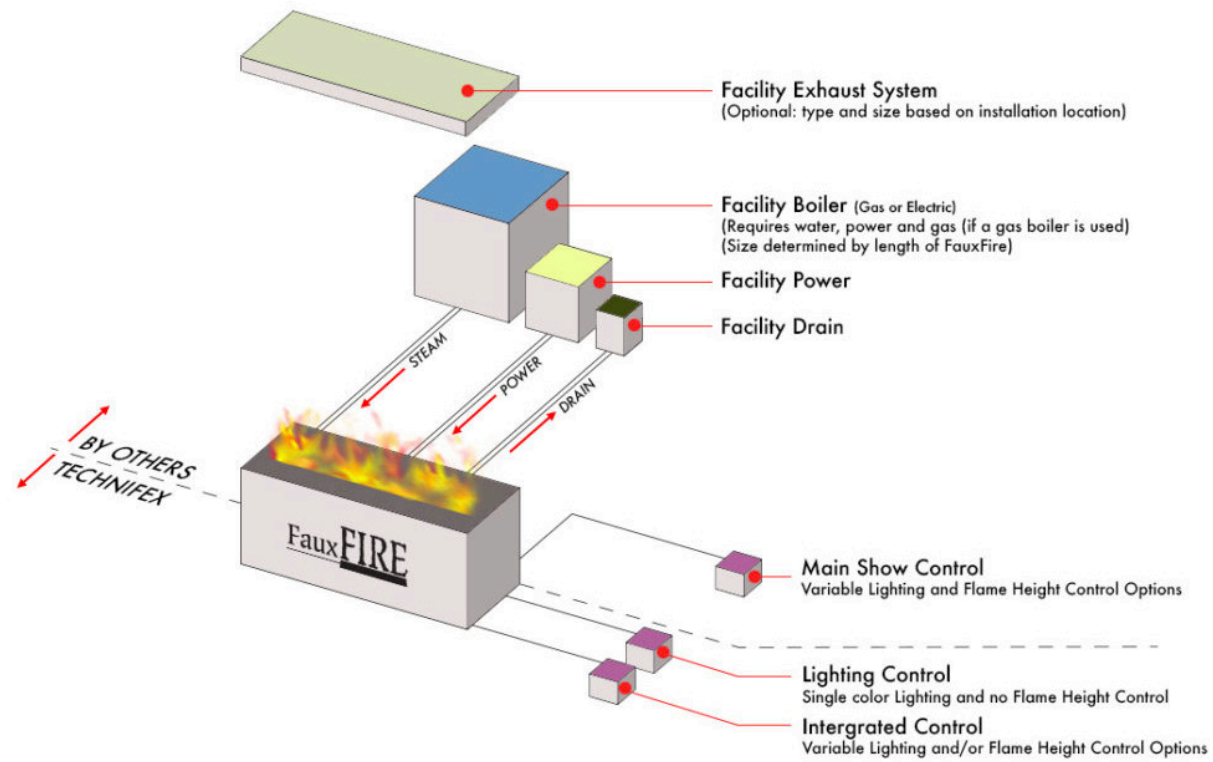

Caroline Siavichay

PROJECT Heal Harm Protect

CLIENT National Museum of Ireland

DATE 12.06.23

GRAPHIC TYPE

GRAPHIC NO.

SCALE

NOTES

KEY PLAN

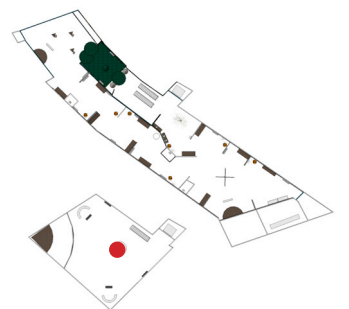

PAGE NO.

76



School of Graduate Studies

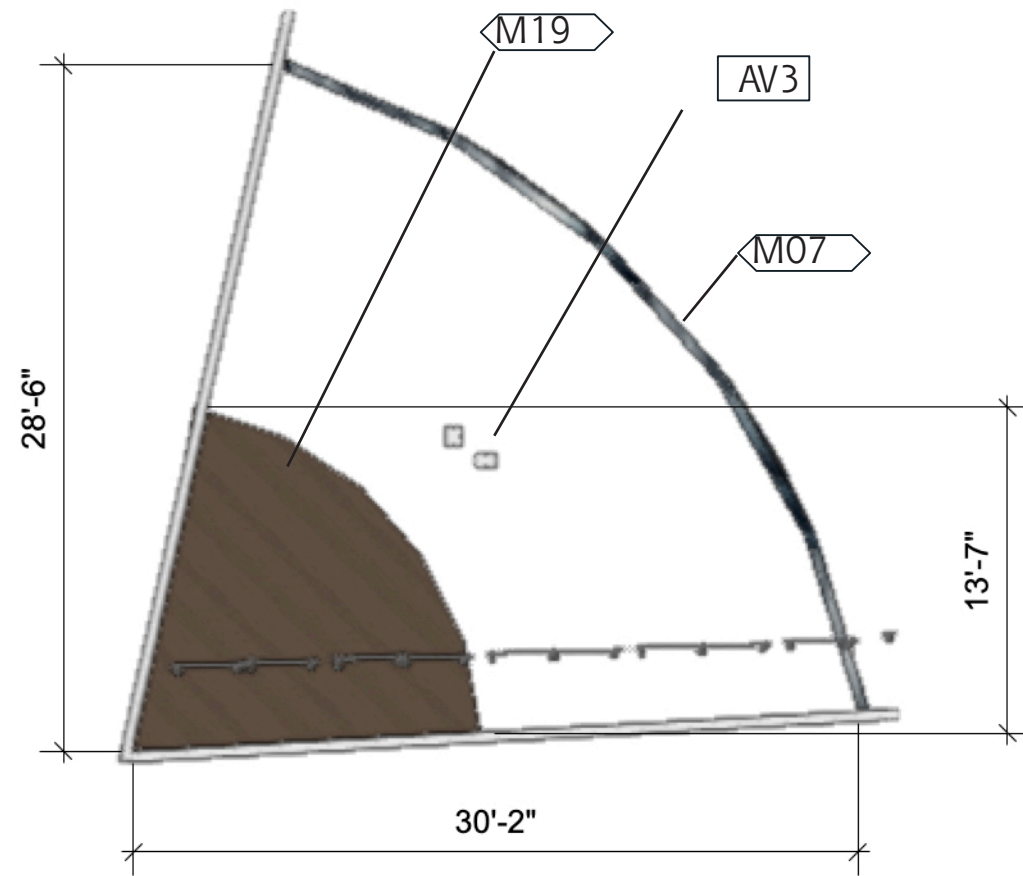

Storytelling Performance Detailing

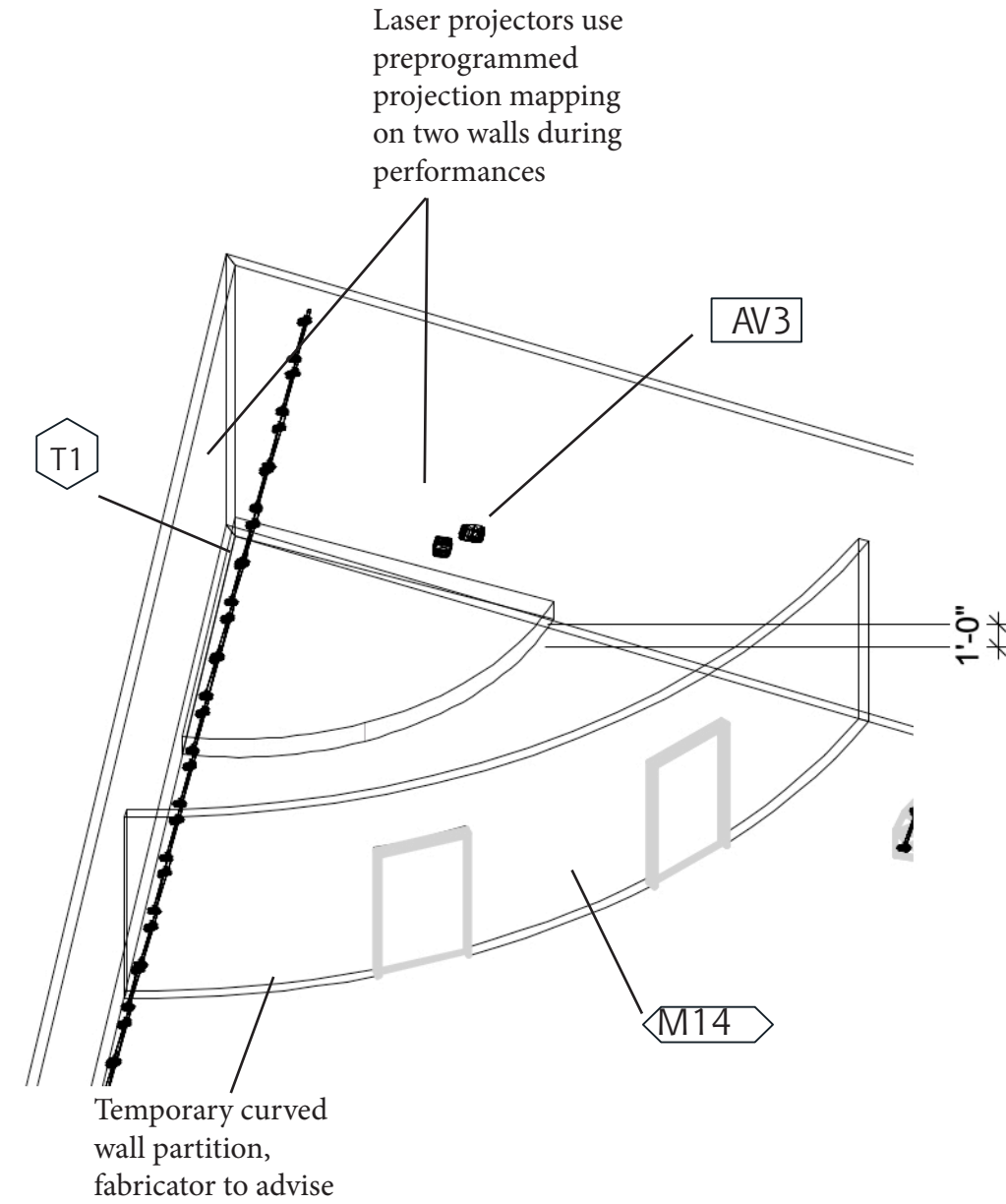

1 **Performance Plan**
Scale: 1/8" = 1'-0"

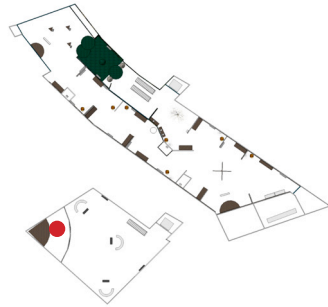

2 **Performance Axon**
Scale: 1/8" = 1'-0"

 Heal Harm Protect	
Caroline Siavichay	
PROJECT	Heal Harm Protect
CLIENT	National Museum of Ireland
DATE	12.06.23
GRAPHIC TYPE	
GRAPHIC NO.	
SCALE	
NOTES	
KEY PLAN	
PAGE NO.	 School of Graduate Studies
77	



Heal Harm Protect

Graduate Thesis
MA Exhibition and Experience Design
Fashion Institute of Technology

Caroline Siavichay
siavichay.caroline@gmail.com
December 2023